

Table of Contents

Commencement 2

Application..... 2

Referral Agency..... 2

Compliance with the QDC..... 2

Relationship between the *Standard* and this part 2

Associated Requirements 2

Referenced Documents 2

Definitions..... 3

Purpose

To safeguard young children from drowning or injury in regulated pools.

Commencement

This version of Mandatory Part (MP) 3.4 of the Queensland Development Code (QDC) commences on 27 July 2012.

Application

This part applies to all regulated pools.

Notes:

1. The term “regulated pool” is defined under the *Building Act 1975*.
2. Existing regulated pools must comply with this part from the “pool safety standard application day” prescribed in section 231A of the *Building Act 1975*.
3. Reference should also be made to sections 36, 37 and 61 of the *Building Act 1975*.

Referral Agency

There is no referral agency for this part.

Compliance with the QDC

Under section 14 of the *Building Act 1975*, compliance with this part can be achieved only by:

- (a) complying with the relevant *acceptable solution* for the performance requirement; or
- (b) formulating an alternative solution that complies with the performance requirement or is shown to be at least equivalent to the relevant requirement; or
- (c) a combination of (a) and (b).

Relationship between the *Standard* and this part

This part prevails over the *Standard* to the extent of any inconsistency.

Associated Requirements

- (a) *Building Act 1975*
- (b) Building Regulation 2006
- (c) Building Code of Australia

Referenced Documents

Number	Date	Amendment number	Title
AS 1926.1	2007	Amendment 1	Swimming pool safety – Part 1: Safety barriers for swimming pools.
AS 1926.2	2007	Amendment 1	Swimming pool safety – Part 2: Location of safety barriers for swimming pools.

Definitions

Relevant definitions in the *Building Act 1975*, the Building Regulation 2006 and the *Standard* (subject to the modifications to the definitions in the *Standard* to the extent of any inconsistency with this part) apply in this part.

Names of Acts and regulations are italicised. Other words within the body of the text that are italicised are defined with the meanings specified below.

Acceptable solution means a relevant building solution which is deemed to satisfy the relevant performance requirement for the purposes of section 14(4)(a)(ii) of the *Building Act 1975*.

Permanently open means in reference to the side of a patio, pergola, verandah, deck, balcony or the like, open space that is, apart from a swimming pool barrier, continuously open to the external environment and not fitted with blinds, insect screening, shade cloth or the like.

Standard means the edition of Australian Standard AS 1926.1 and AS 1926.2 referenced by this part.

Temporary fence means a fence which is not a permanent structure, has at least one gate, otherwise complies with this part and is securely fixed to resist reasonably foreseeable actions to which it may be subjected.

**PERFORMANCE
REQUIREMENTS**

ACCEPTABLE SOLUTIONS

Swimming pool barriers

- | | |
|--|--|
| <p>P1 Swimming pools must have a barrier which:</p> <ul style="list-style-type: none">(a) is continuous for the full extent of the hazard; and(b) is of a strength and rigidity to withstand the foreseeable impact of people; and(c) restricts the access of young children to the pool and the immediate pool surrounds, including access from class 1, 2 or 3 buildings or class 4 parts of buildings located within or outside the pool area; and(d) has any gates fitted with latching devices not readily operated by young children, and constructed to automatically close and latch; and(e) except for indoor swimming pools, does not incorporate any doors providing access to or from a building. | <p>A1 Swimming pools must have a barrier complying with the <i>Standard</i>, subject to the:</p> <ul style="list-style-type: none">(a) modifications to the <i>Standard</i> specified in schedule 1; and(b) tolerance limits specified in a guideline for swimming pool barriers made under section 258 of the <i>Building Act 1975</i>. |
|--|--|

Schedule 1 – Modifications to the *Standard*

Standard clauses affected	Standard modifications
AS1926.1:2007	
1.3.5	1. The height of a fence must be measured and comply with this part on the same side of the fence as the non-climbable zone.
1.3.12	2. The definition of the term “swimming pool” in the <i>Standard</i> is: (a) replaced by the definition of “swimming pool” in the <i>Building Act 1975</i> ; and (b) the meaning given to that term in the <i>Building Act 1975</i> applies to the term “pool” throughout the <i>Standard</i> .
2.1	3. (a) A <i>temporary fence</i> may be used instead of a permanent barrier for a maximum period of 3 months from the date the fence was inspected and approved as a <i>temporary fence</i> by a building certifier. (b) A building certifier may give written approval for the use of the <i>temporary fence</i> instead of a permanent barrier for further periods of up to 3 months from the date the fence was inspected and approved as a <i>temporary fence</i> if the building certifier is satisfied that the safety of young children would not be at risk if the approval were given. 4. For building work done under Schedule 2C, section 5 of the Building Regulation 2006: (a) a <i>temporary fence</i> may be used instead of a permanent barrier for a maximum period of 3 months and (b) a <i>temporary fence</i> may be used instead of a permanent barrier for a second period, but only if a pool safety inspector has issued a nonconformity notice in relation to the pool and only during the first 3 months after issue of the notice and (c) a pool safety inspector or a building certifier may give written approval for the use of the <i>temporary fence</i> instead of a permanent barrier for third or subsequent periods of up to 3 months if, after inspecting the fence, they are satisfied that the safety of young children would not be at risk if the approval were given.
Figure 2.1	5. Figures 1 to 13 apply instead of figure 2.1.
2.3.1	6. The non-climbable zone must be located, for a fence, including a boundary fence: (a) less than 1800 millimetres in height - on the outside of the fence (i.e. the side facing away from the pool area); and (b) 1800 millimetres or more in height - on either the outside or the inside of the fence. 7. A boundary fence may be less than 1800 millimetres in height, but not less than 1200 millimetres in height, provided the non-climbable zone is located on the outside of the fence (i.e. the side facing away from the pool area). 8. Climbable objects are permitted within the upper 900 millimetres quadrant of the non-climbable zone, provided it is not reasonably possible for a young child to gain access to those climbable objects (see figure 9).

	<p>9. If the non-climbable zone is provided on the outside of a fence (i.e. the side facing away from the pool area), an additional clear area must be provided immediately adjacent to the outside of the fence to maintain the effective height of the fence (see figures 1 to 9, 12, 13, 15, 16, 18 and 22).</p> <p>10. If the non-climbable zone is provided on the outside of a fence (i.e. the side facing away from the pool area), the non-climbable zone must extend 900 millimetres beyond the end of a fence and also beyond the intersection of a fence with another barrier or object and an additional clear area complying with clause 9 of this schedule must also be provided (see figures 15 and 16).</p> <p>11. For barriers 1800 millimetres or more in height, any non-climbable zone on the inside of the barrier (i.e. the side facing into the pool area) may be intersected by a swimming pool barrier, provided the width of the top rail or surface of the intersecting barrier is not more than 50 millimetres wide at any point within the non-climbable zone (see figures 14 (a) & (b)).</p>
2.3.2	<p>12. The non-climbable zone, clear area and additional clear area required by this part are not required for a fence complying with clause 2.3.2 if the fence is:</p> <p>(a) 2400 millimetres or more in height (see figure 17 (a)); or</p> <p>(b) 1800 millimetres or more in height with an additional cranked top complying with figure 17 (b).</p>
2.3.4(b)	<p>13. The dimension of 900 millimetres applies instead of 1000 millimetres and is measured from the top surface of the highest lower horizontal member to the top surface of the lowest upper horizontal member or surface.</p>
Figure 2.5	<p>14. Figure 18 applies instead of figure 2.5.</p>
2.5.1	<p>15. Gates and, for indoor swimming pools, doors must not open towards the pool area (see figures 30 and 31).</p>
2.6.2 and figure 2.7(c)	<p>16. The overhang or return fencing must have a surface that does not provide any projection or indentation forming a handhold or foothold and must be located at the outer edge of the retaining wall or other such barrier so as not to provide a handhold or foothold (see figure 2.7(c) in the <i>Standard</i>).</p>
2.6.3	<p>17. A canal, lake, river, creek, stream, pond, ocean or dam may form part of a barrier where:</p> <p>(a) the depth of water is continuously more than 300 millimetres at any point of the area of body of water adjacent to the barrier specified in 17(b); and</p> <p>(b) the width of the body of water immediately adjacent to the edge of the pool area being protected is equal to or exceeds 1800 millimetres at any point of the body of water: and</p> <p>(c) access is not available to the pool over or under the body of water (see figure 20, 21a and 21b); and</p> <p>(d) required barriers intersecting the body of water, either</p> <p>(i) extend to the edge of the water and either overhangs the water by 900 millimetres; or</p> <p>(ii) return 900 millimetres along the edge of the water in at least one direction (see figure 19); and</p> <p>(e) the overhang or return fencing required by 17(d) must have a surface that does not provide any projection or indentation forming a handhold or foothold that would aid climbing (see</p>

MP 3.4 – SWIMMING POOL BARRIERS

	figure 19).
2.8	18. Clause 2.8 does not apply, other than for indoor swimming pools.
2.9	19. In addition to the requirements of clause 2.9, a non-climbable zone complying with figure 23 must be provided unless a barrier complying with this part is provided to the balcony.
Figure 2.9	20. Figure 22 applies in addition to figure 2.9 of the <i>Standard</i> .
2.10	21. In addition to the requirements of clause 2.10, a designated swimming pool access point must be provided, regardless of whether or not a permanent access ladder is installed. The access point must be enclosed by a barrier, including a gate that complies with this part.
Appendix D	22. The dimension of 900 millimetres applies instead of 1000 millimetres throughout Appendix D.
AS1926.2:2007	
3.3, 3.6, 3.7, 4.3, 4.4.2 and Appendix A	23. Clauses 3.3, 3.6, 3.7, 4.3 and 4.4.2 and Appendix A do not apply.
3.8, 3.10 and 3.13	24. (a) The definition of the term “swimming pool” in the <i>Standard</i> is: (i) replaced by the definition of “swimming pool” in the <i>Building Act 1975</i> ; and (ii) the meaning given to that term by the <i>Building Act 1975</i> applies to the term “pool” throughout the <i>Standard</i> . (b) The definitions of “indoor pool” and “outdoor pool” in the <i>Standard</i> are replaced by the definitions of “indoor swimming pool” and “outdoor swimming pool” in the <i>Building Act 1975</i> respectively (see figure 32).
3.11	25. The term “building” applies instead of the term “house”.
4.4.1	26. Access to an indoor swimming pool must be via a child-resistant doorset that complies with this part or via another barrier that complies with this part. Where windows are present in the barrier, they must be child-resistant in accordance with this part.
4.2 and figure 2.1	27. The term “class 1, 2 or 3 building or class 4 part of a building” applies instead of the term “building”. 28. Despite anything in this part to the contrary, a barrier may permit direct access to the pool area from a patio, pergola, verandah, deck, balcony or the like (of any class) with at least one <i>permanently open</i> side provided that the barrier otherwise complies with this part (see figures, 27, 28 and 29). 29. In addition to the requirements of clause 4.2 and figure 2.1, the access of young children to the pool and the immediate pool surrounds from a class 1, 2 or 3 building or class 4 part of a building located within the pool area must be restricted by a barrier complying with this part, unless the building is a patio, pergola, verandah, deck, balcony or the like (of any class) with at least one <i>permanently open</i> side and access is via a compliant barrier (see figure 24 and 25). 30. In addition to the requirements of clause 4.2 and figure 2.1, if a building or structure of any class allows access by young children from outside the pool area to inside the pool area, a barrier complying with this part must be provided to restrict the access (see figure 26).

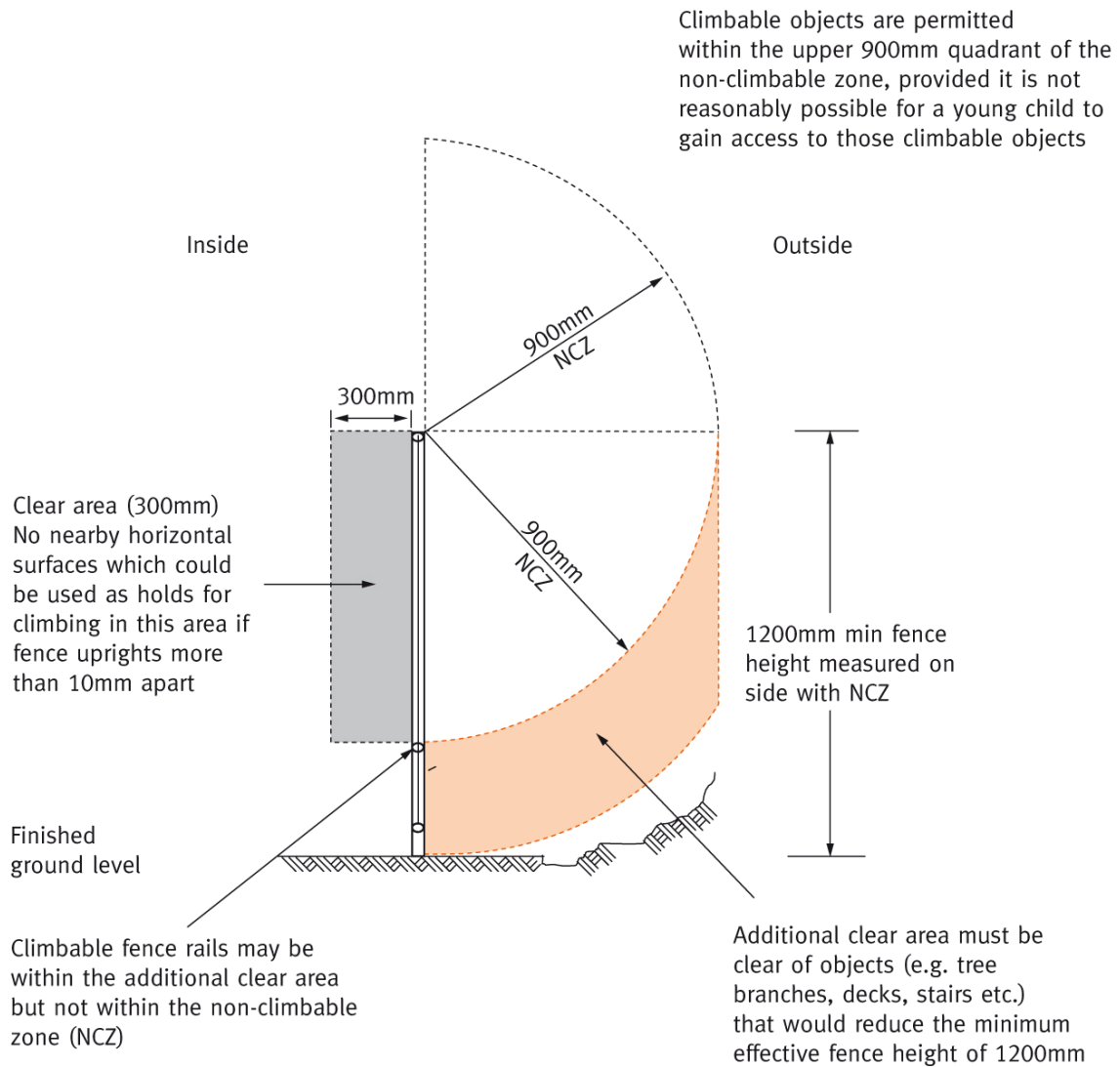

Figure 1
1200mm min high fence NCZ on outside
Acceptable

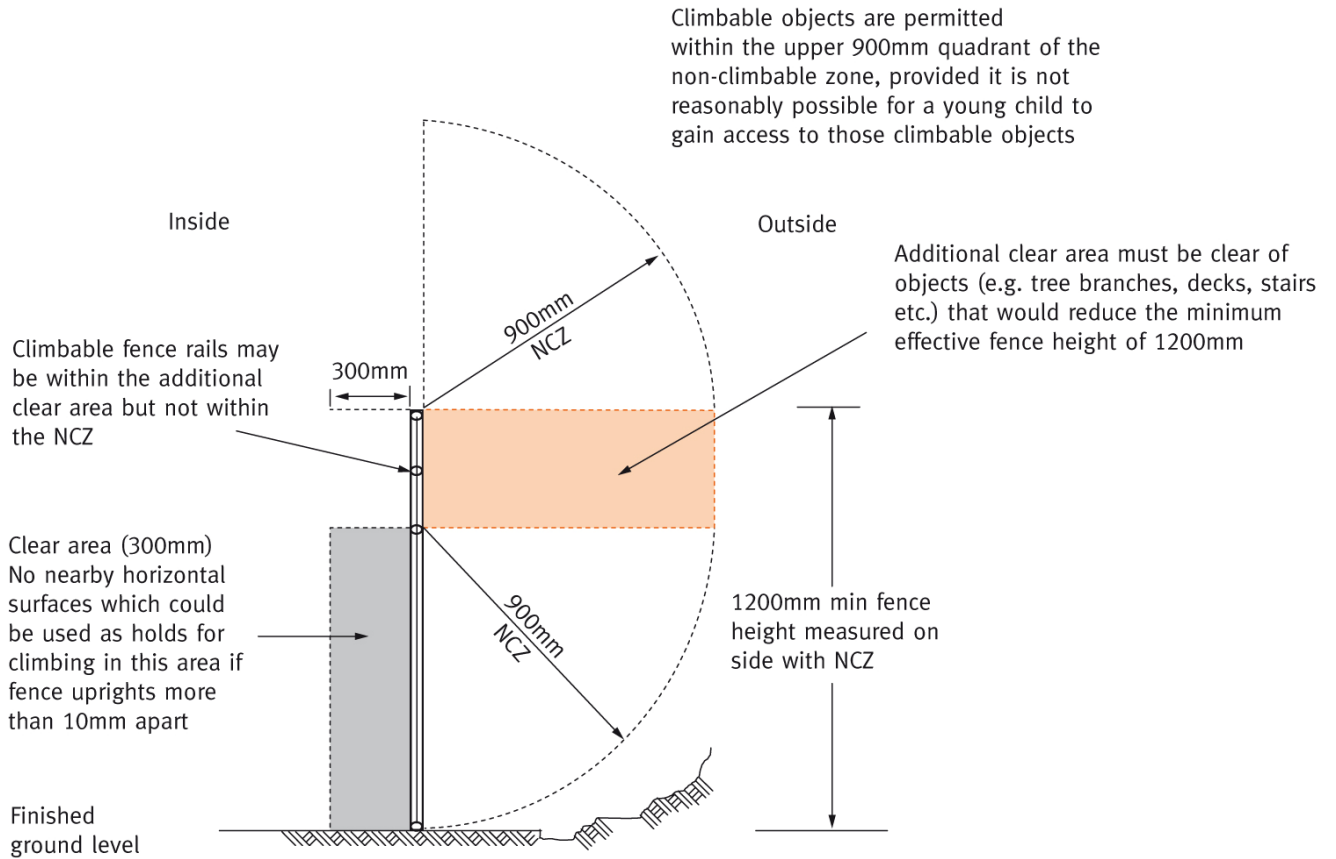

Figure 2
1200mm min high fence NCZ on outside
Acceptable

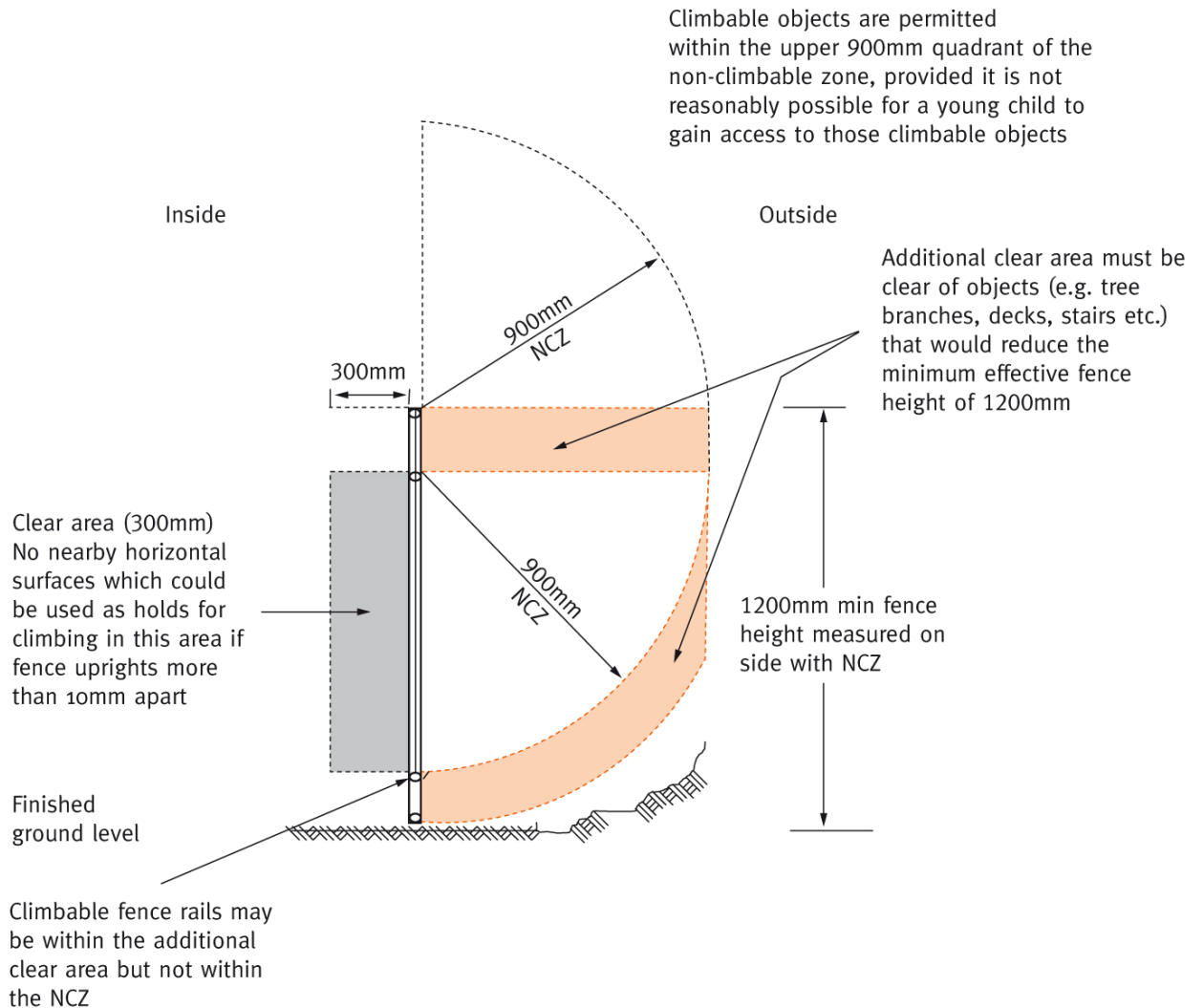

Figure 3
1200mm min high fence NCZ on outside
Acceptable

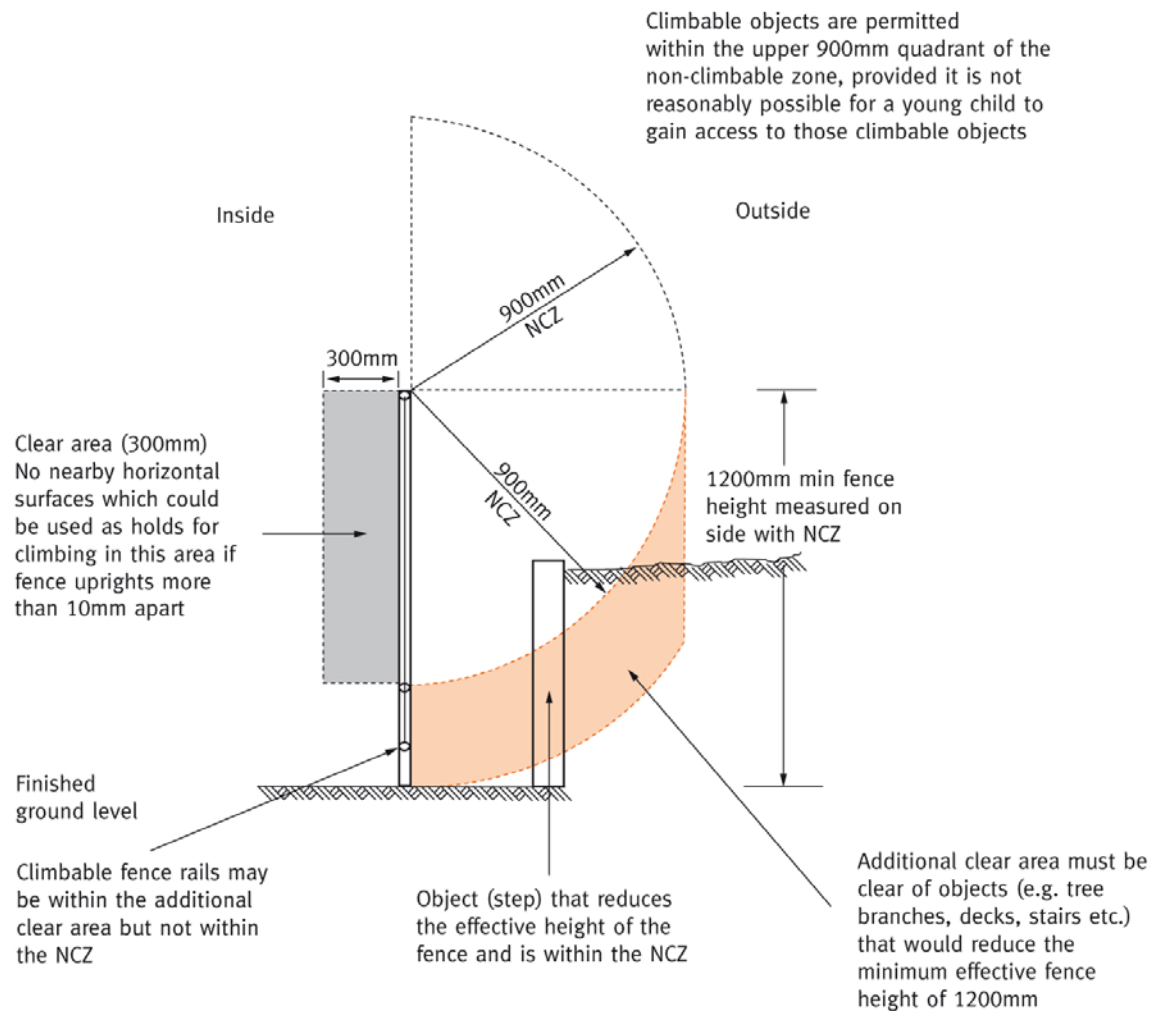

Figure 4
1200mm min high fence NCZ on outside
Not acceptable

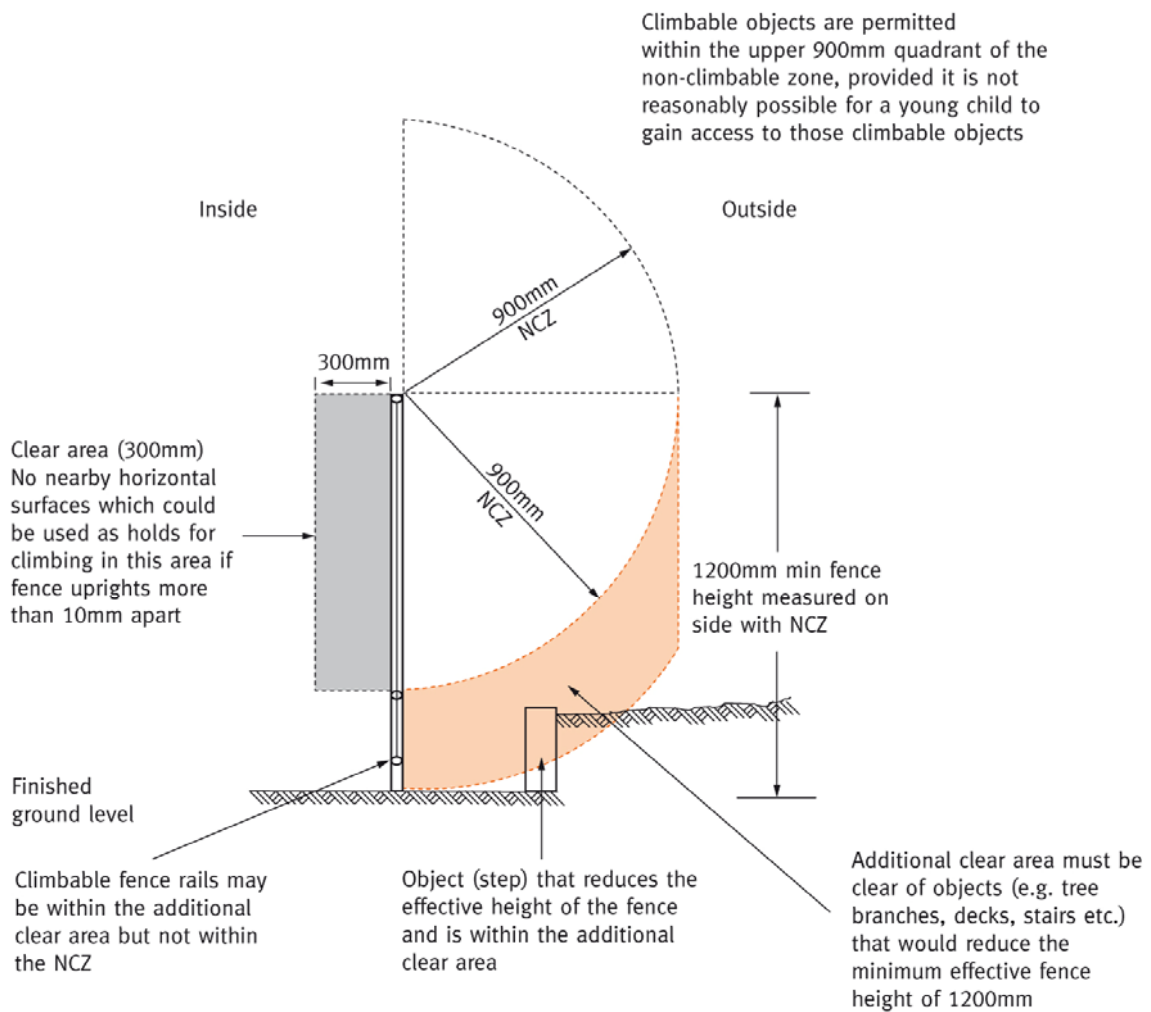

Figure 5
1200mm min high fence NCZ on outside
Not acceptable

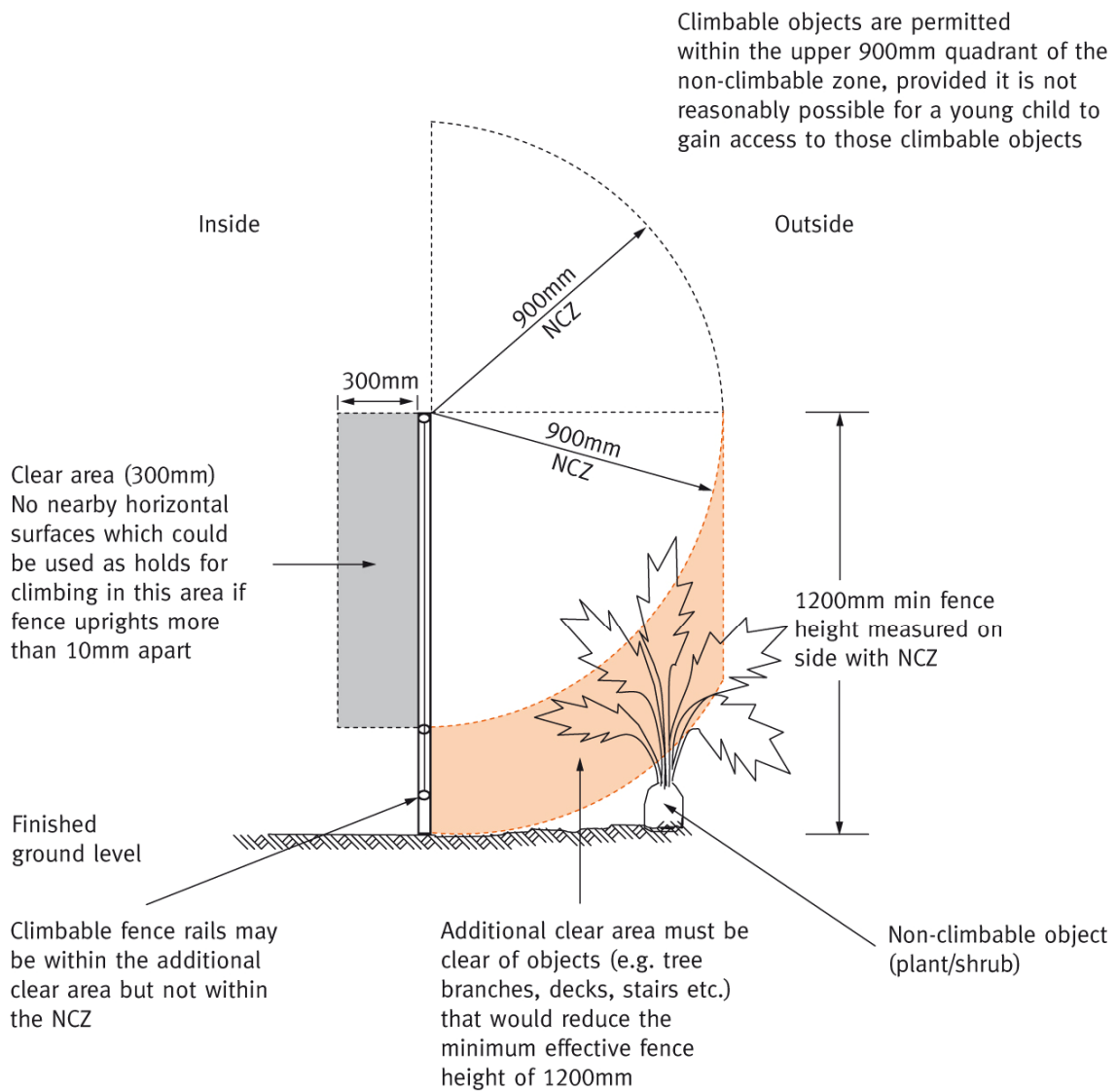

Figure 6
1200mm min high fence NCZ on outside
Acceptable

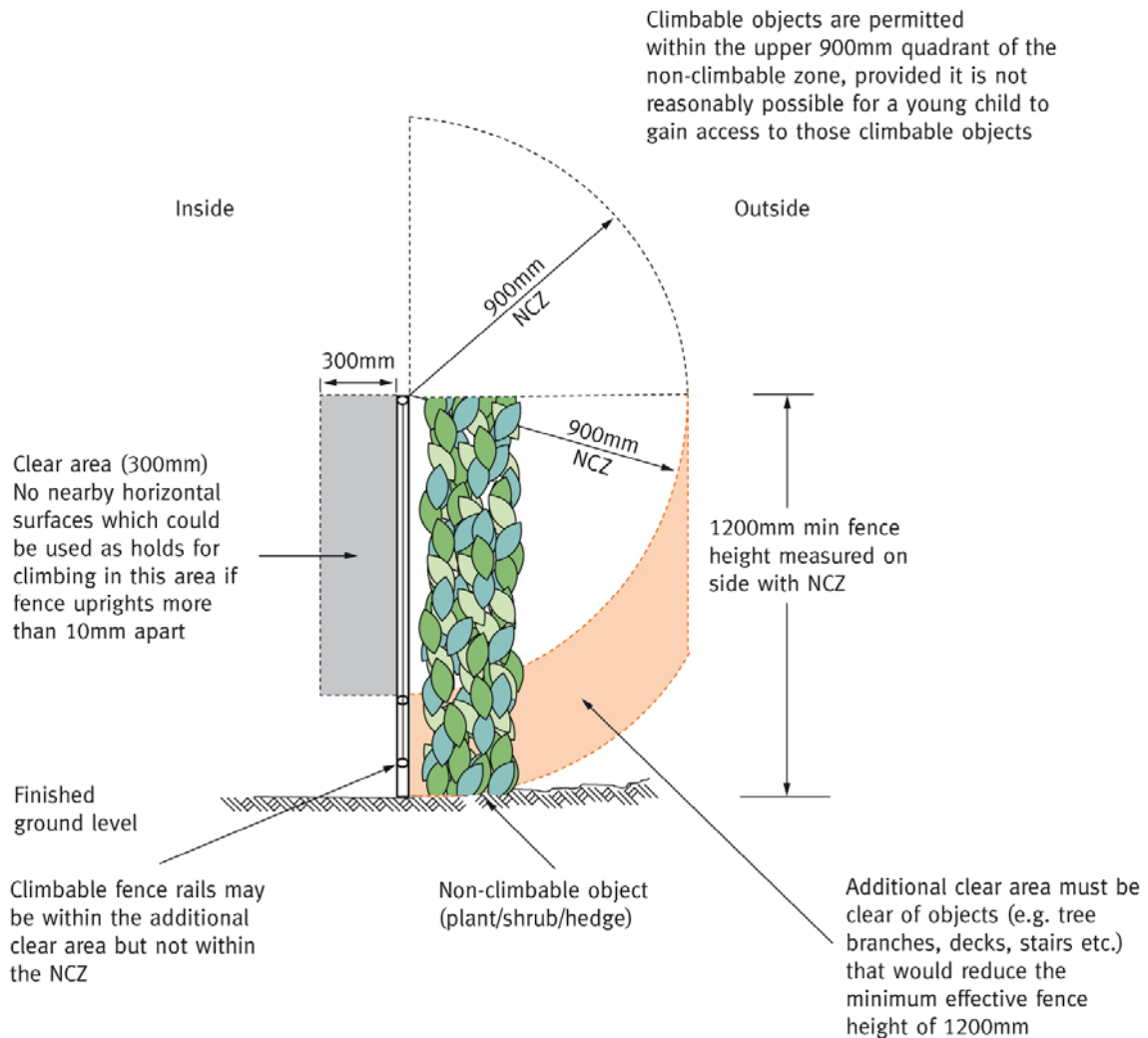

Figure 7
1200mm min high fence NCZ on outside
Acceptable

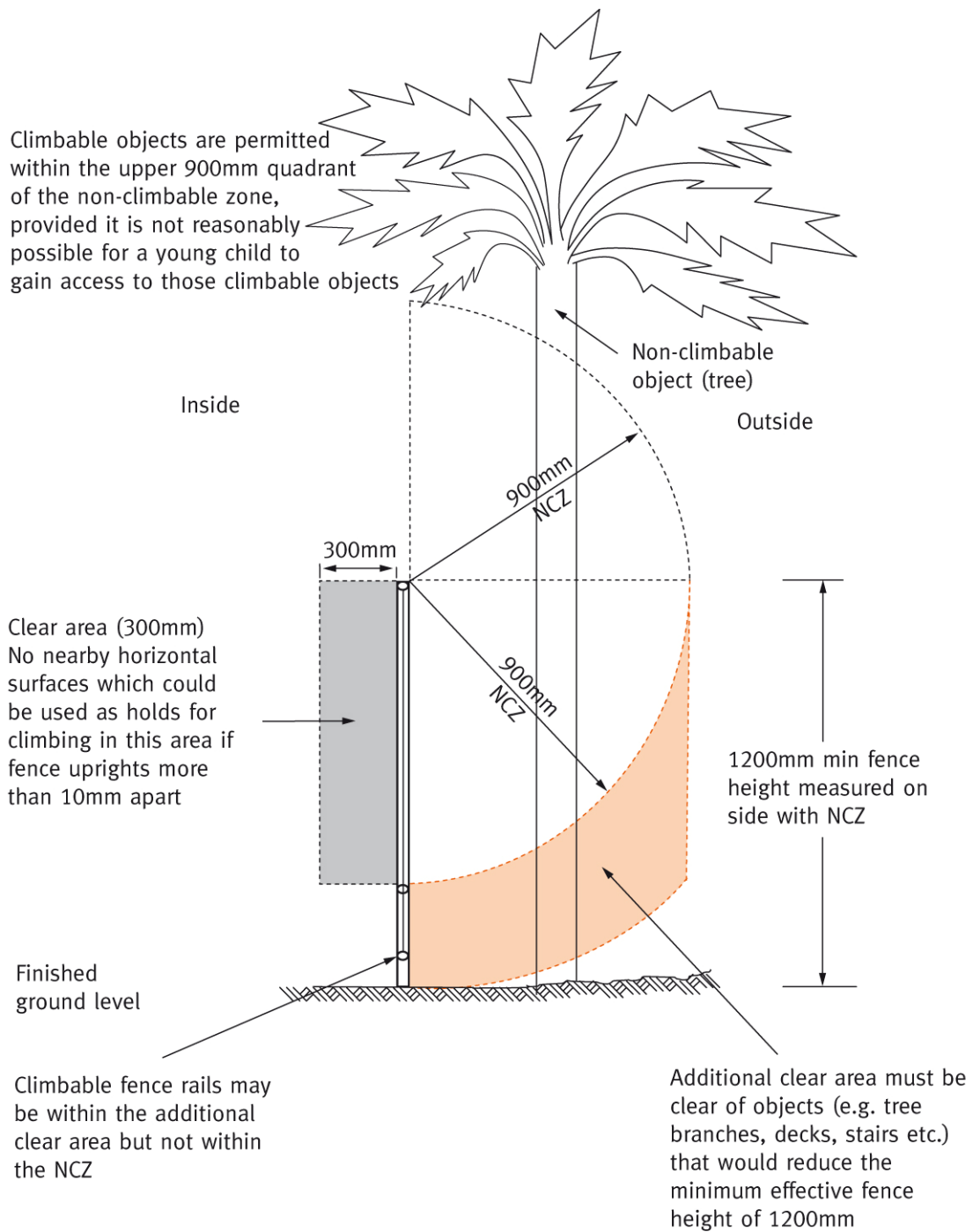

Figure 8
1200mm min high fence NCZ on outside
Acceptable

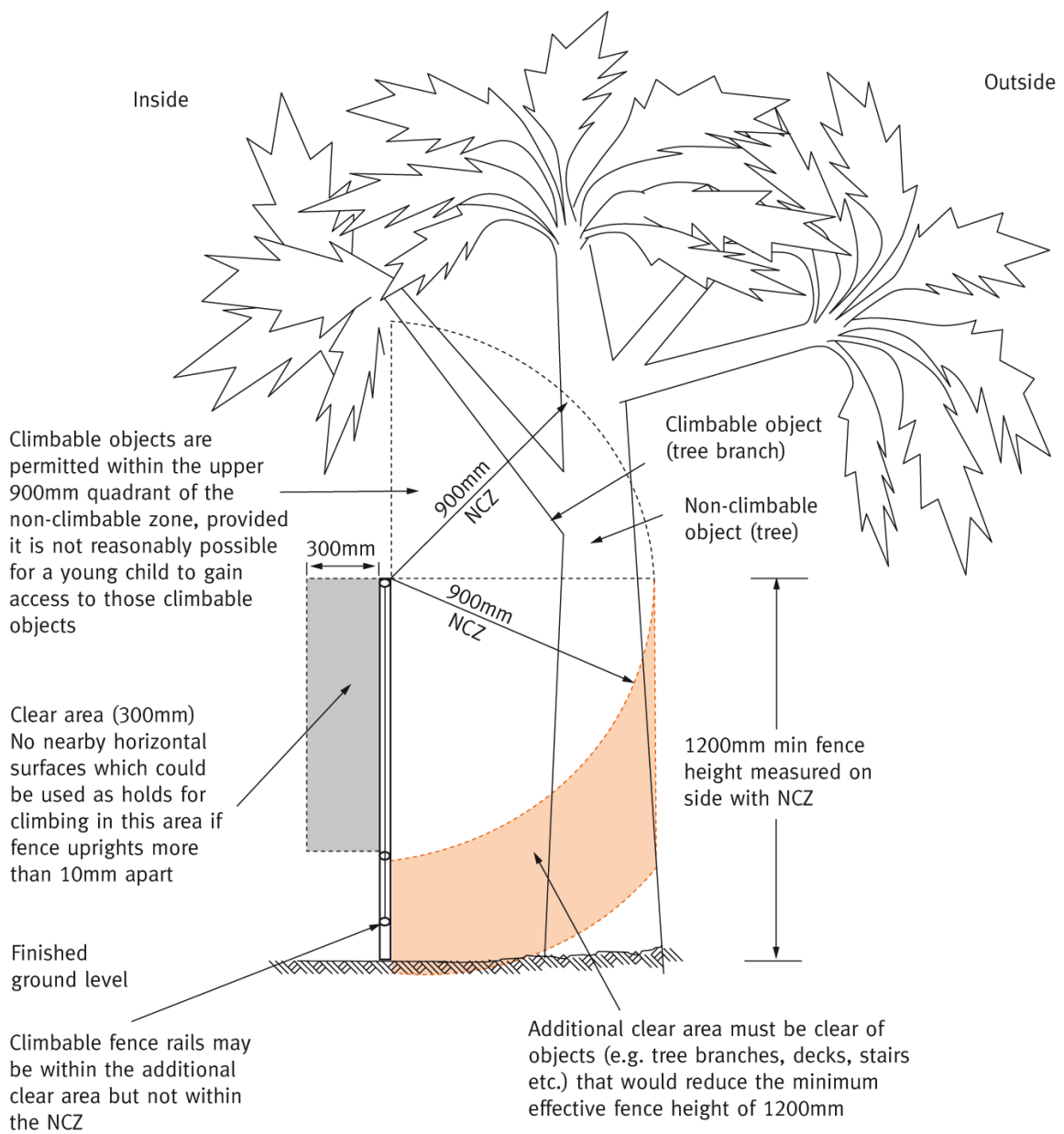
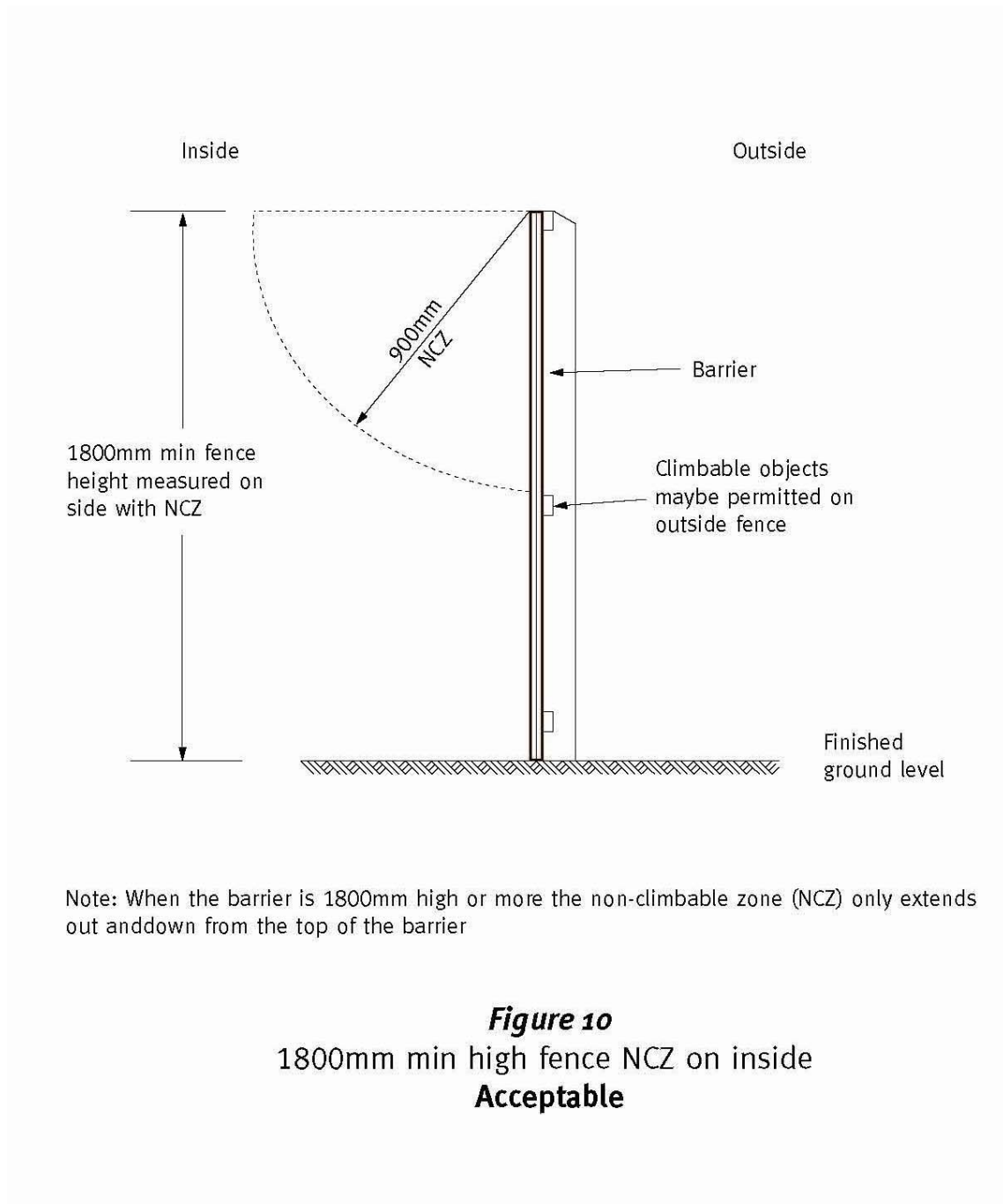
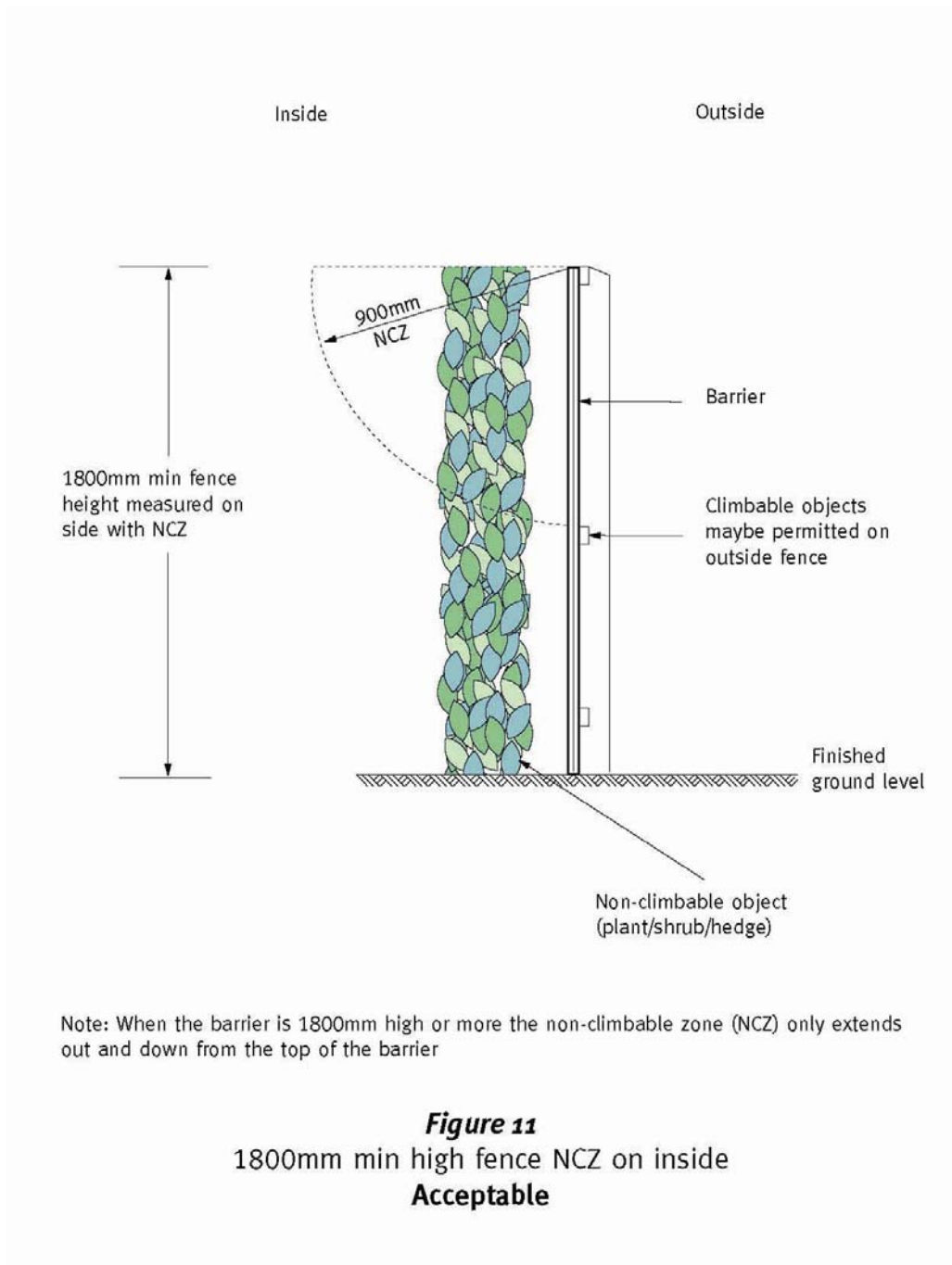

Figure 9
1200mm min high fence NCZ on outside
Acceptable





Climbable objects are permitted within the upper 900mm quadrant of the non-climbable zone, provided it is not reasonably possible for a young child to gain access to those climbable objects

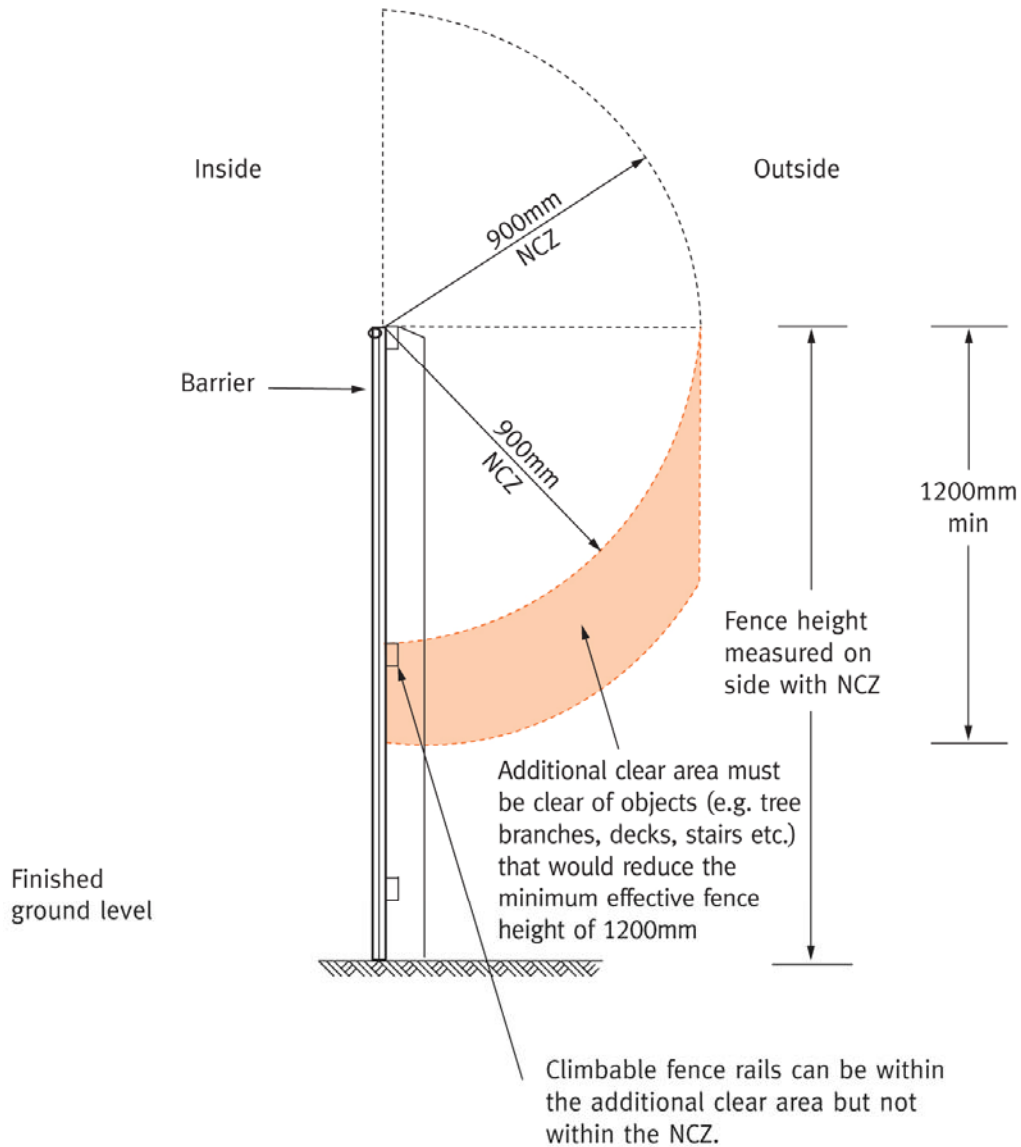

Figure 12
Fence greater than 1200mm min high NCZ on outside
Acceptable

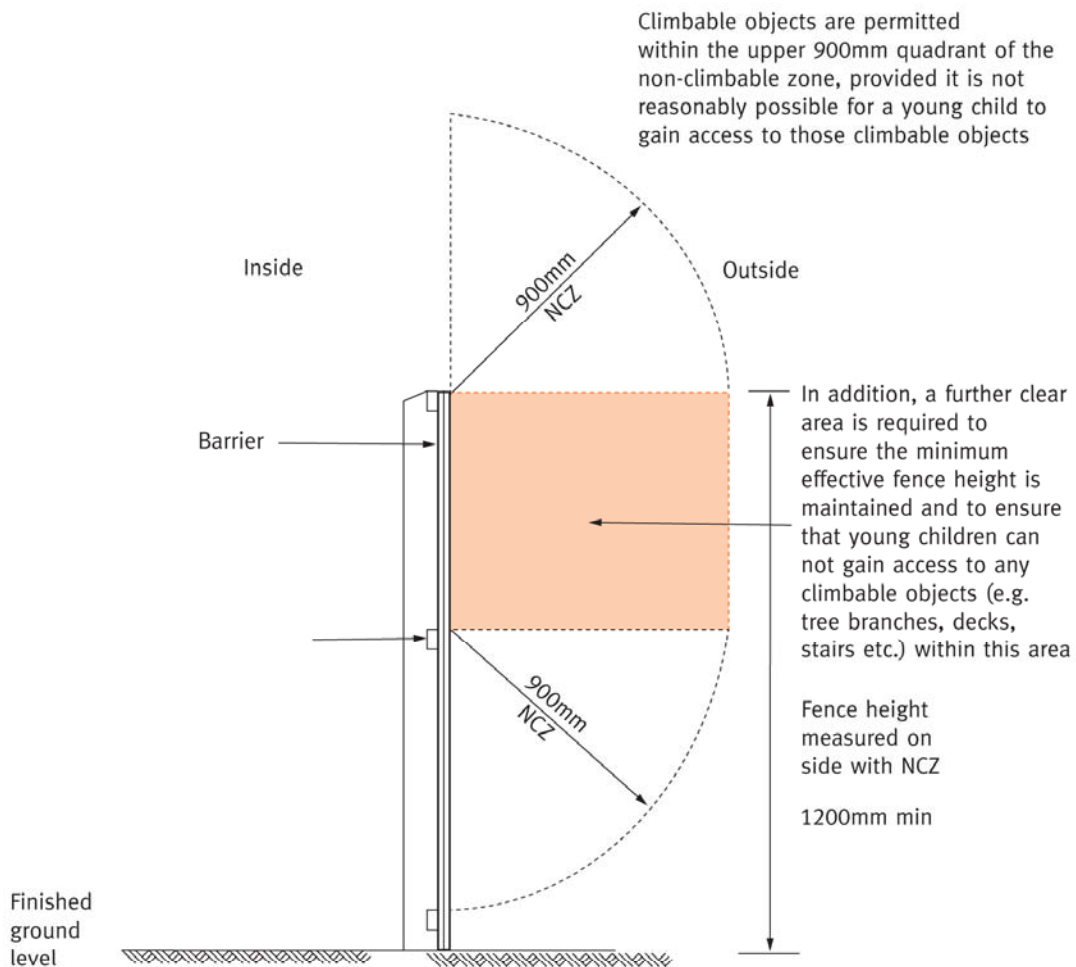

Figure 13
 Fence greater than 1200mm min high NCZ on outside
Acceptable

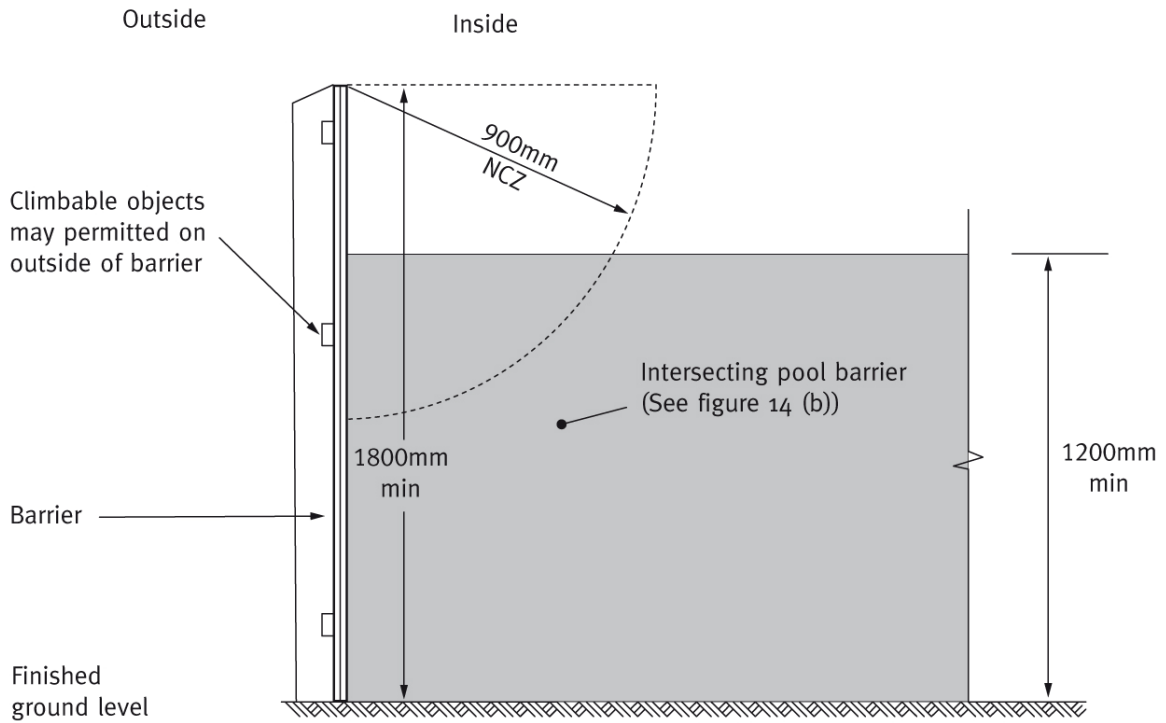

Figure 14 (a) (Section and Elevation)

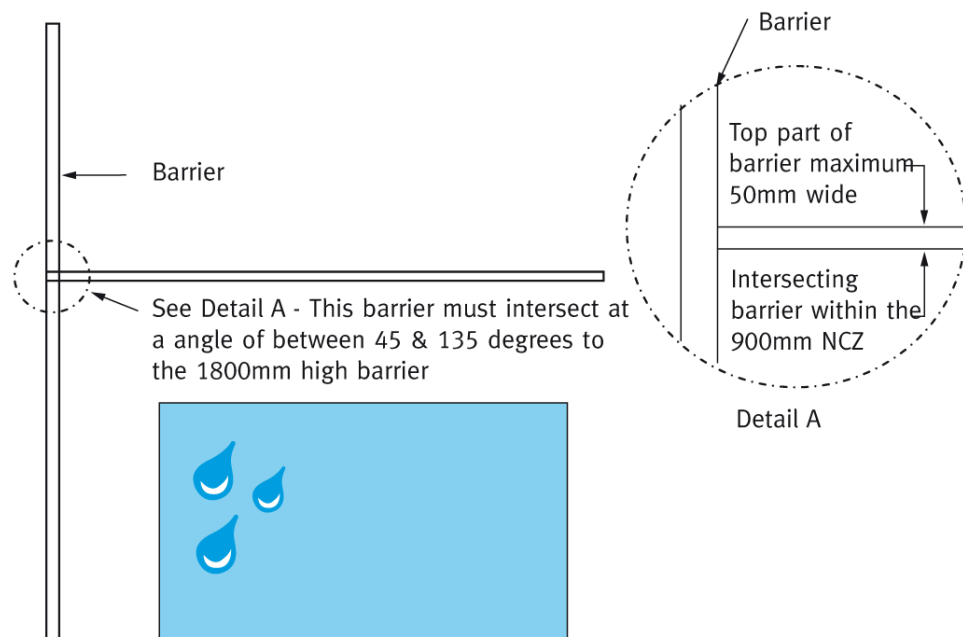
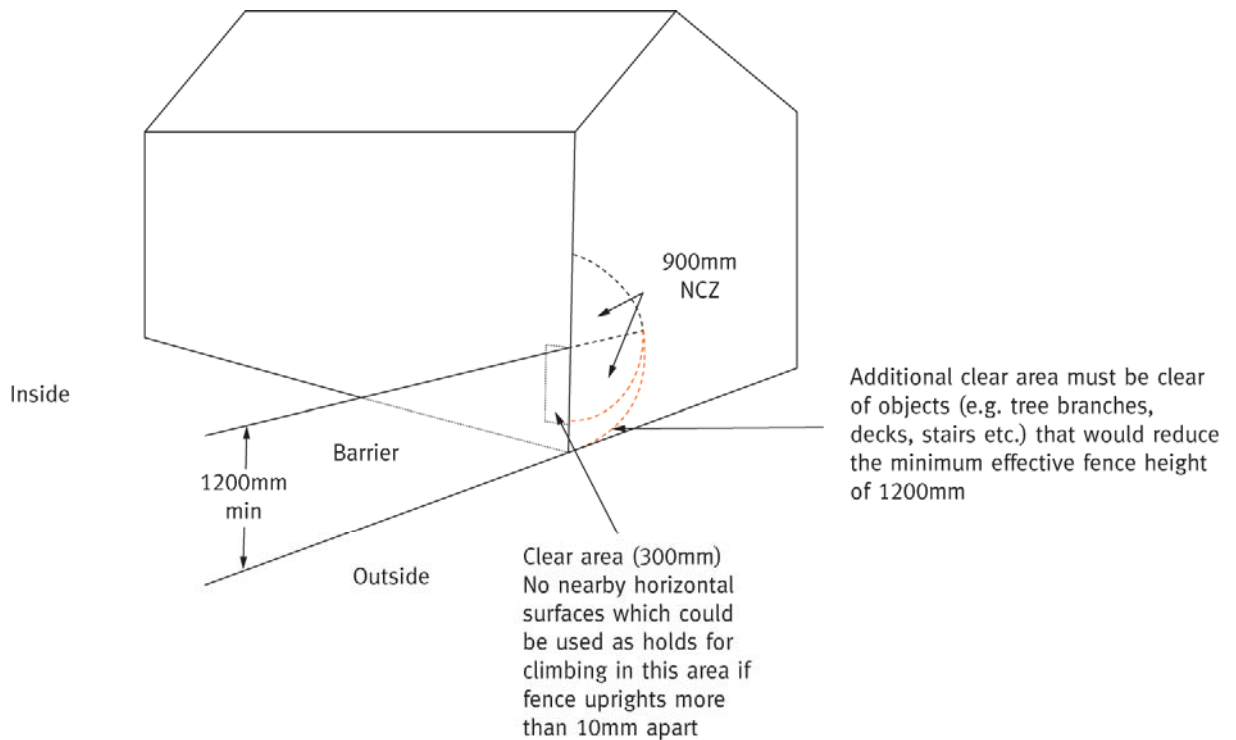

Figure 14 (b) (Plan View)

Figure 14(a) & (b)
 1800mm high barrier NCZ on inside with intersecting barrier
Acceptable



Note: The non-climbable zone (NCZ) continues in spherical form at the intersection of the pool barrier with the structure to the wall of the structure. The additional clear area continues in an arc past the intersection to the wall of the structure.

Figure 15
Pool barriers intersecting with other structures
Acceptable

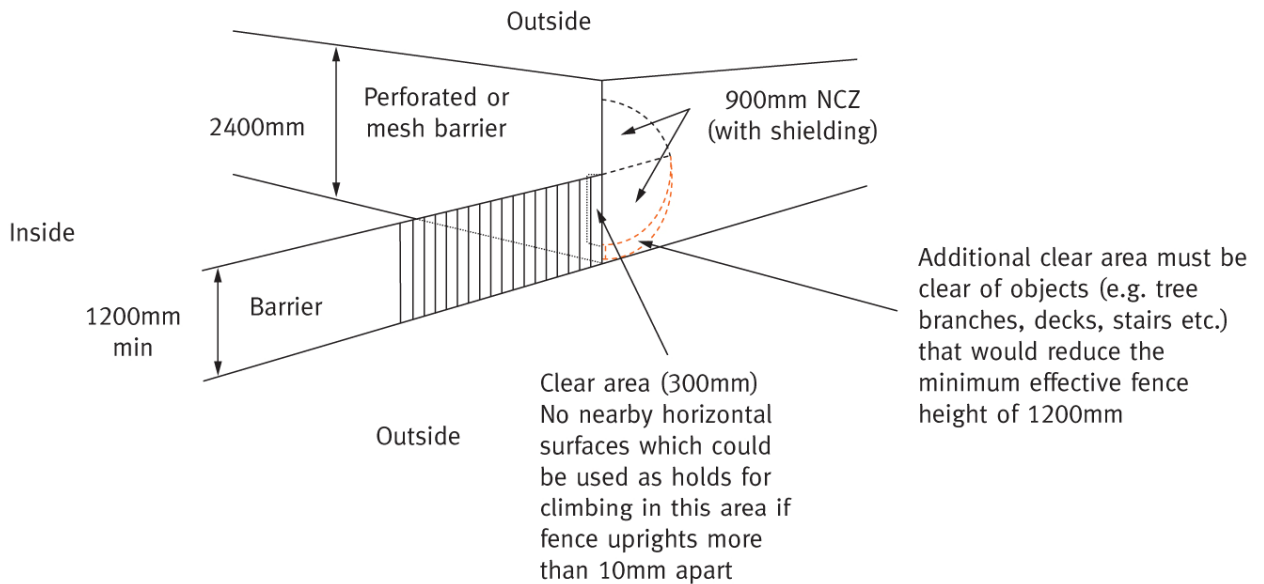

Note: The non-climbable zone (NCZ) continues in spherical form at the intersection of the pool barrier with the structure to the wall of the structure. The additional clear area continues in an arc past the intersection to the wall of the structure.

Figure 16
Pool barriers intersecting with perforated material or mesh barrier
Acceptable

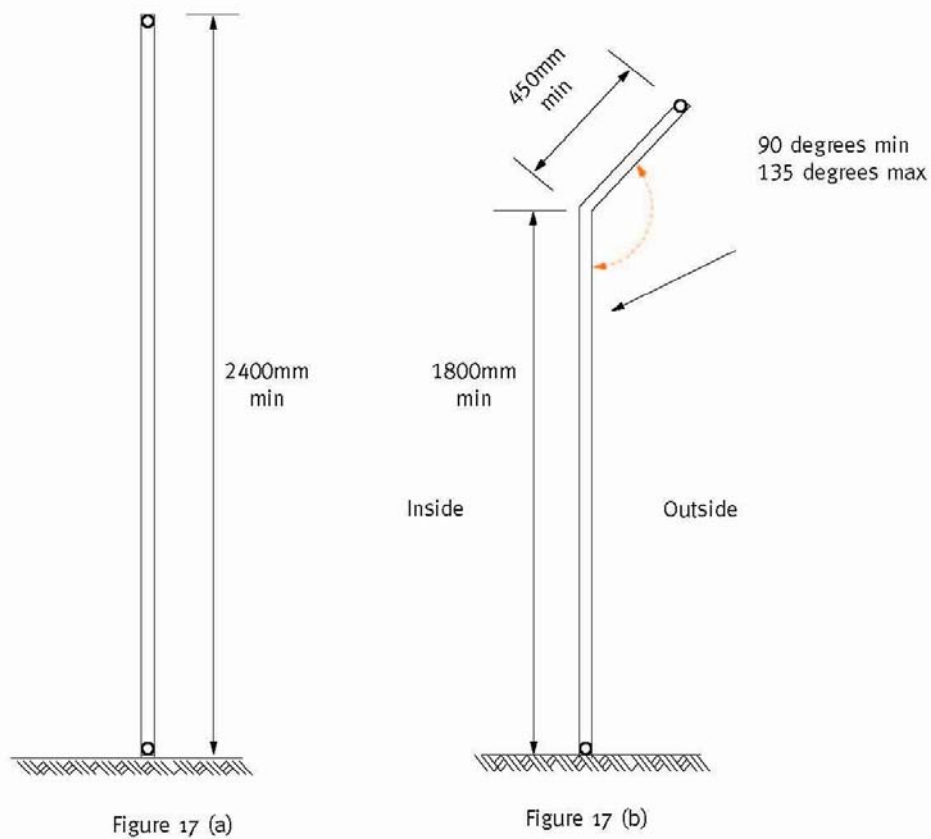

Note: Barriers using perforated material or mesh with apertures greater than 13mm but less than 100mm shall comply Figure 17(a) or (b) Barriers using mesh must include a strainer wire or rail at the top and bottom of the fencing In Figure 17(b) the cranked top shall have apertures less than 100mm

Figure 17(a) & (b)
Pool barriers with perforated material or mesh
Acceptable

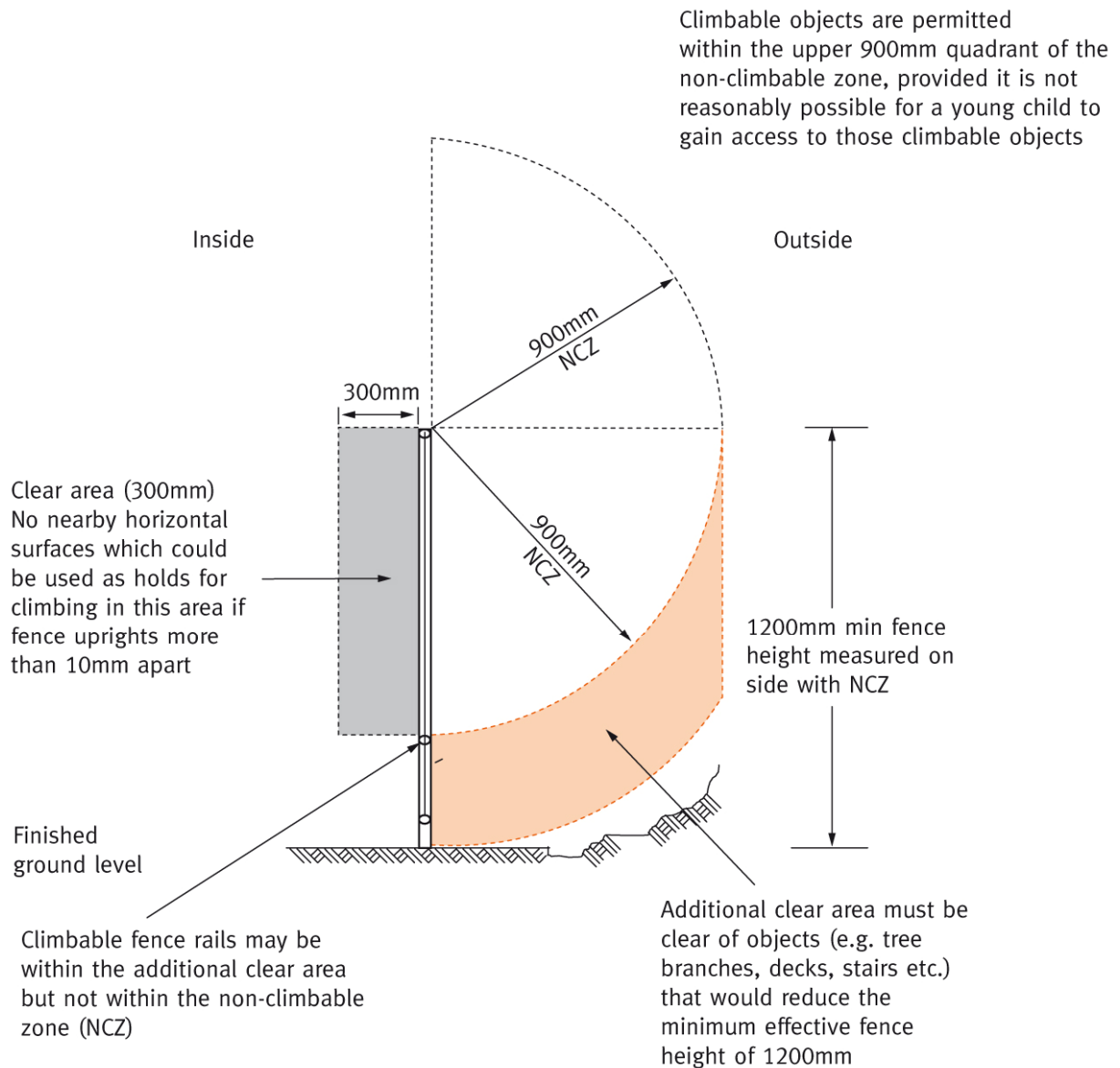
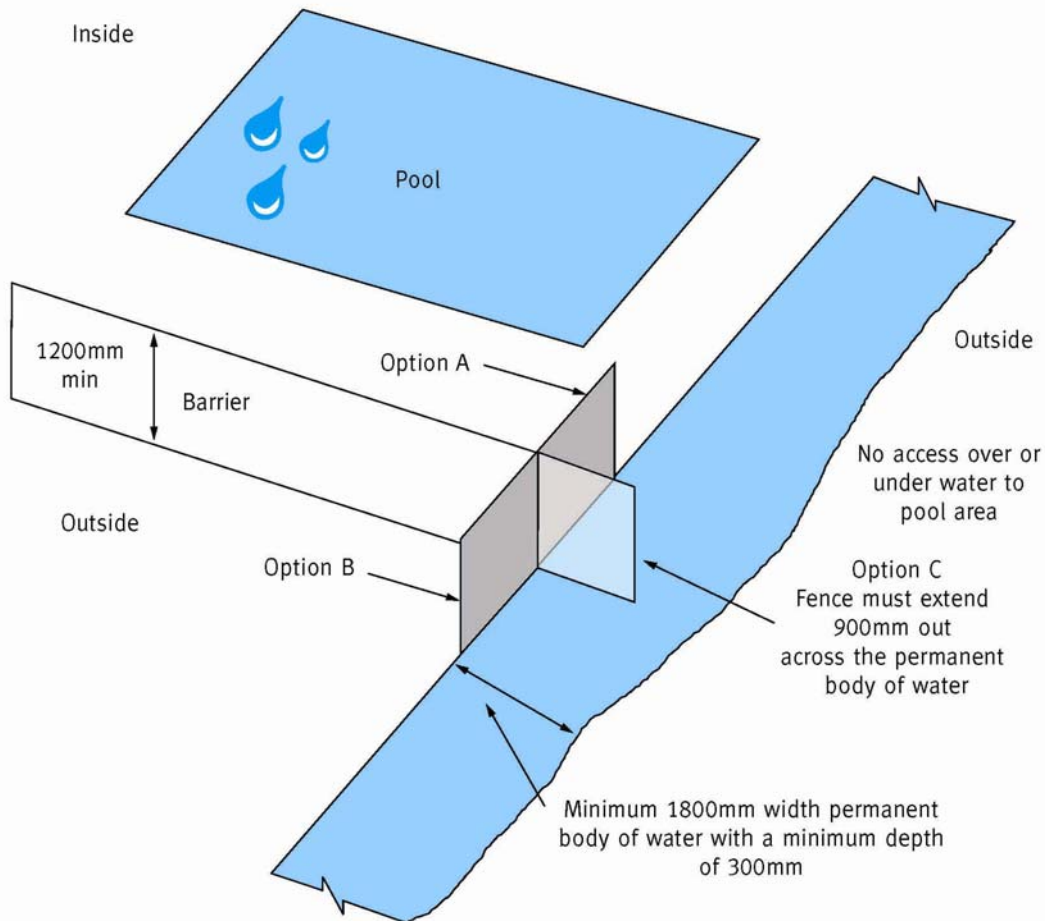

Figure 18
Fencing with horizontal surfaces inside the fencing
Acceptable



Note: A permanent body of water may only be used as a barrier if it is a canal, lake, river, creek, stream, pond, ocean, dam or the like. In options A, B & C the overhang or return fencing (900mm length) must have a surface that does not provide any handhold or foothold and when located on a retaining wall must be at the outer edge of the wall or other such barrier so as not to provide a handhold or foothold. If two adjoining properties have a swimming pools only one of the options (A, B or C) need to be constructed. In option C the barrier must be within the title boundary and may need local government or state approval.

Figure 19
Permanent body of water acting as a swimming pool barrier
Acceptable

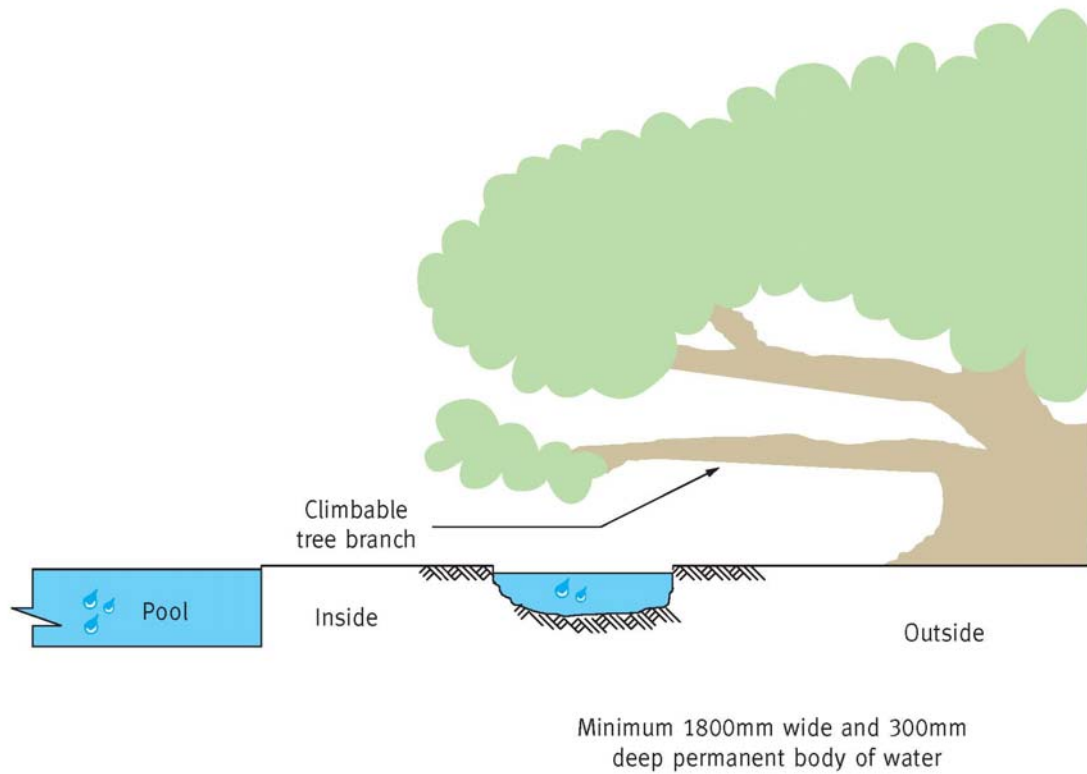

Figure 20
Permanent body of water acting as a swimming pool barrier
Not Acceptable

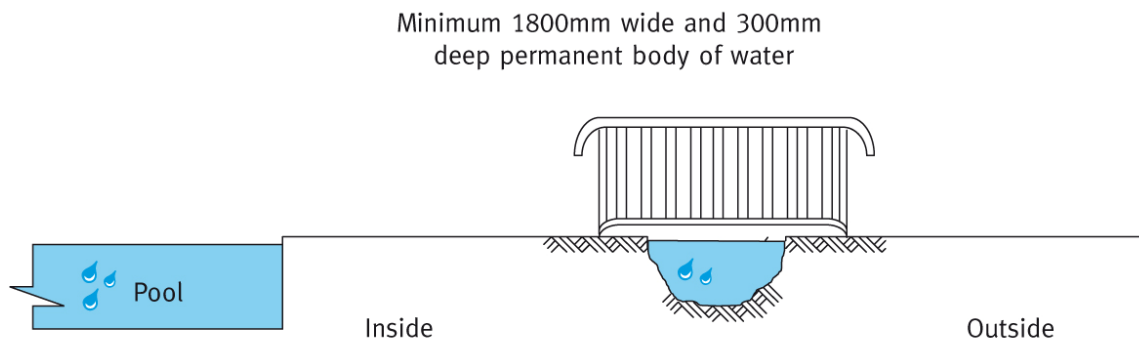

Figure 21 (a) Access provided over the permanent body of water (bridge, walkway or Pontoon or the like)

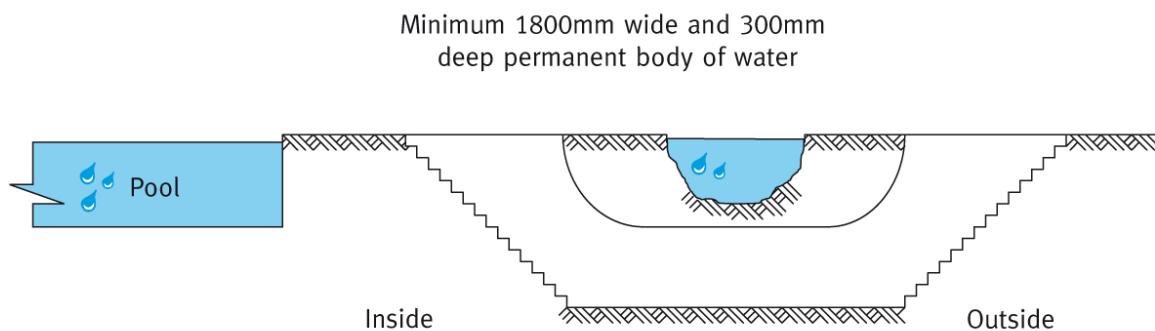

Figure 21 (b) Access provided under the permanent body of water (tunnel, pipe or service duct or the like)

Figure 21(a) & (b)
Permanent body of water acting as a swimming pool barrier
Not Acceptable

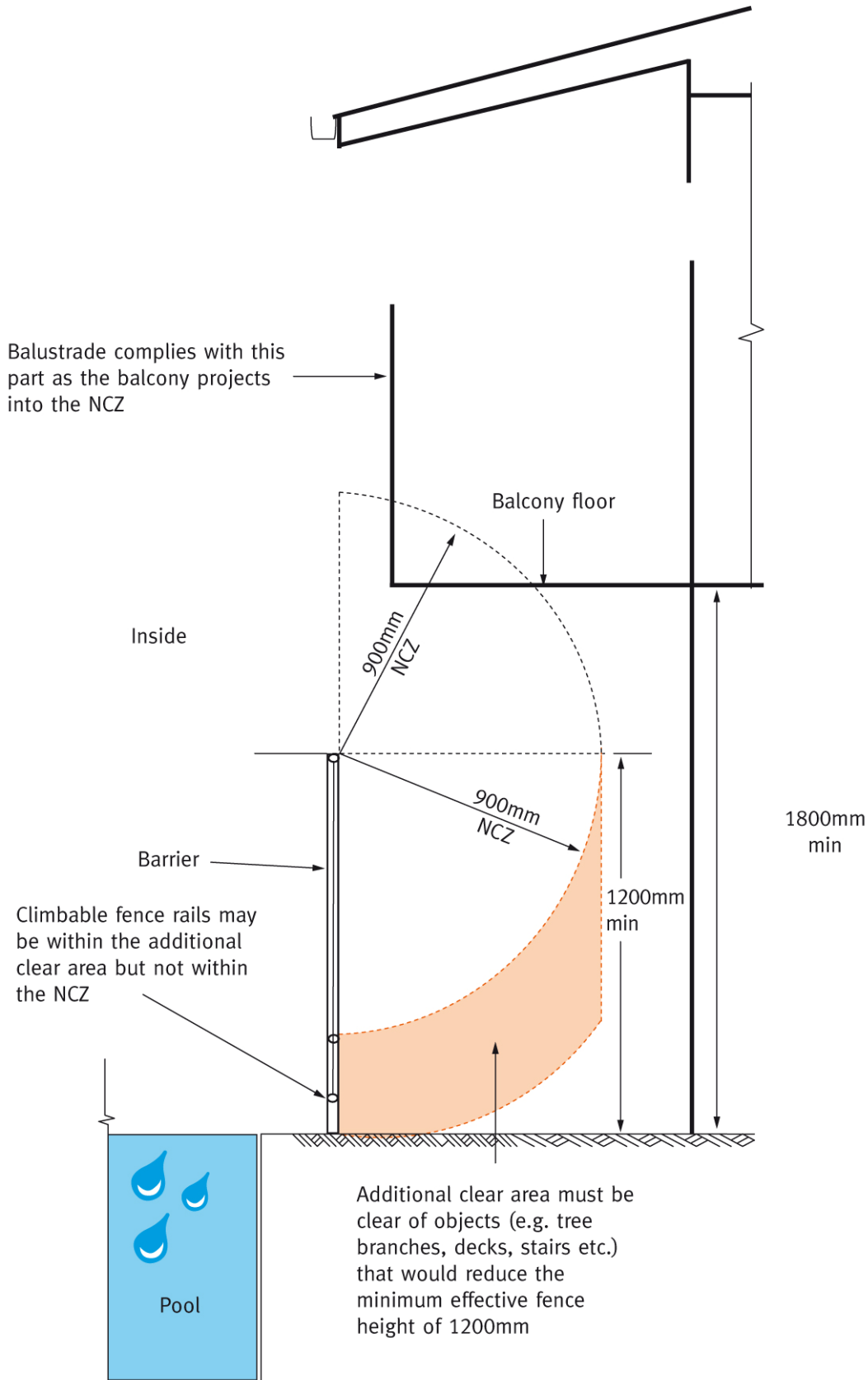

Figure 22
Balcony adjacent pool area
Acceptable

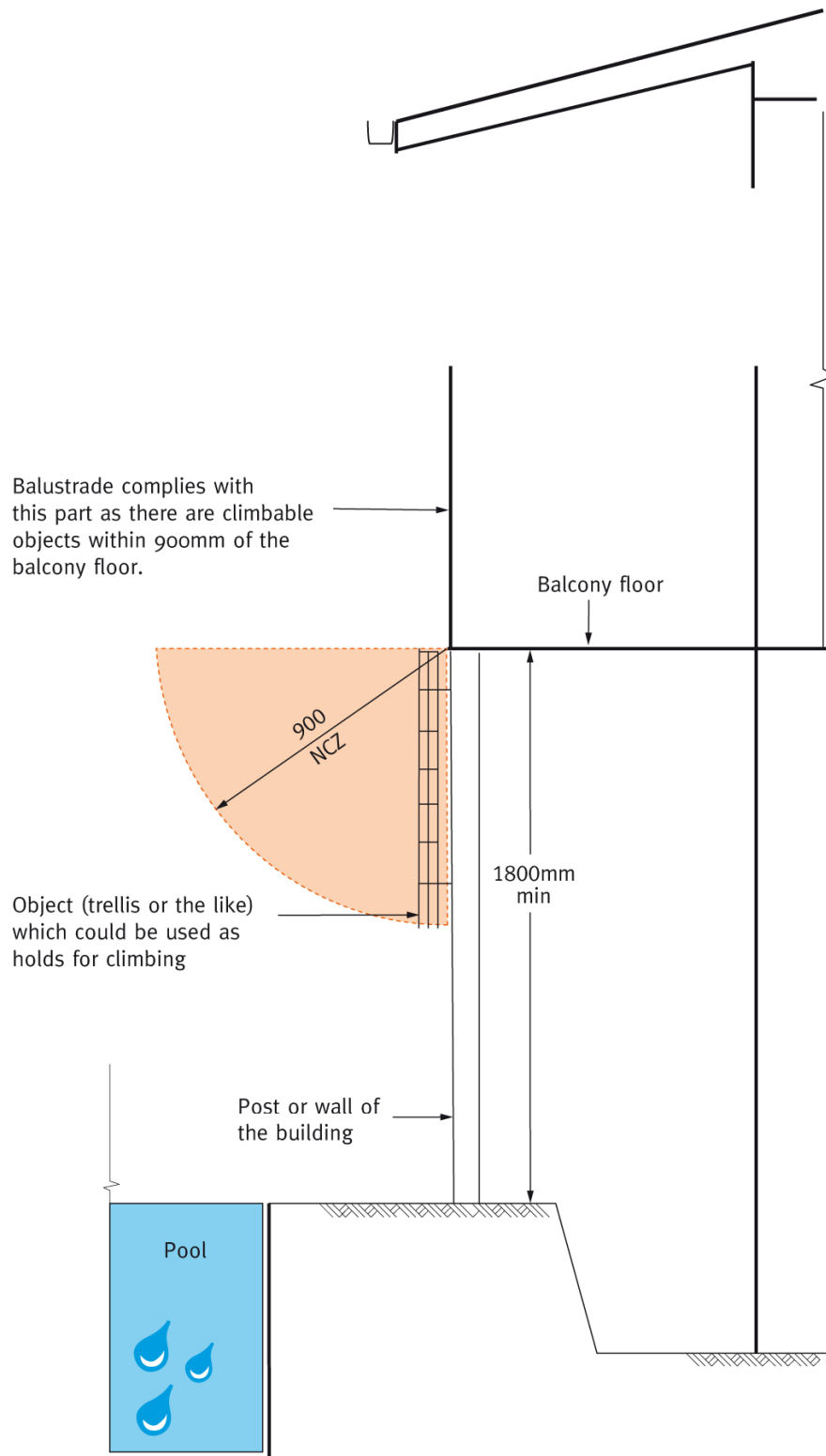
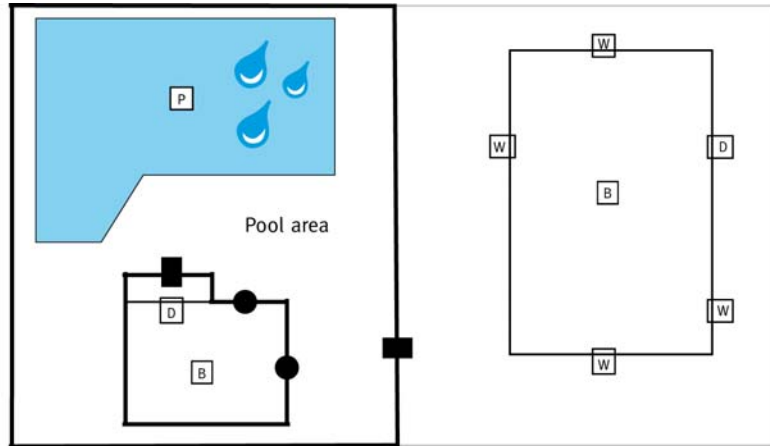

Figure 23
Balcony adjacent pool area
Acceptable



LEGEND:

P Pool

B Building

D Door

W Window

Gate complying with this part

Child-resistant openable portion of window

— Property boundary

— Walls or line of the building

— Fence, retaining wall or other barrier complying with this part

If the building within the pool area is a patio, pergola, verandah, deck, balcony or the like (of any class) having at least one side permanently open, it is not required to have a barrier.

Figure 24

Access from a Class 1, 2 or 3 building or Class 4 part of a building within a pool area must be via a barrier complying with this part

Acceptable

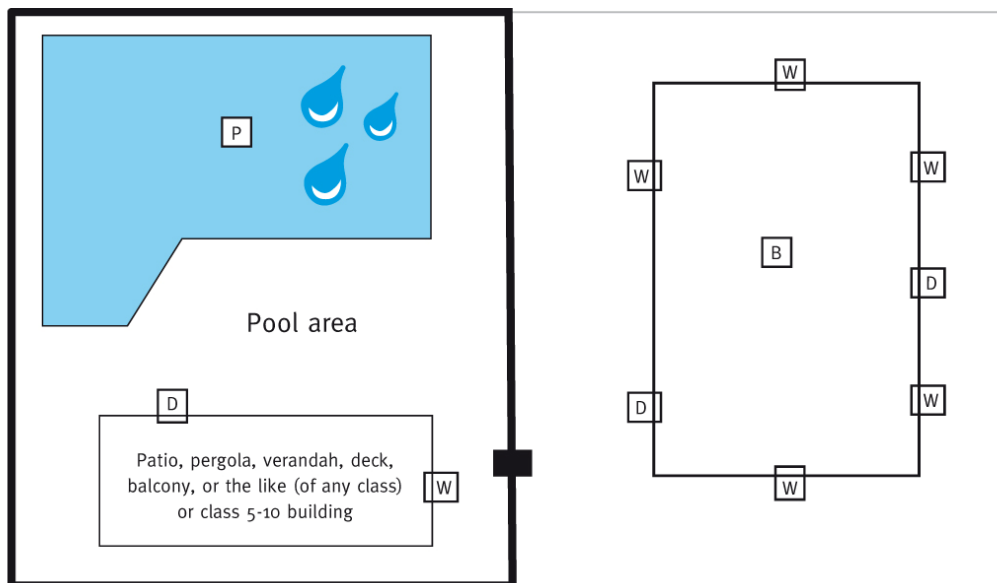

LEGEND:

- P Pool
- B Building
- D Door
- W Window
- Gate complying with this part
- Child-resistant openable portion of window
- Property boundary
- Walls or line of the building
- Fence, retaining wall or other barrier complying with this part

If the building within the pool area is a patio, pergola, verandah, deck, balcony or the like (of any class) having at least one side permanently open, it is not required to have a barrier

Figure 25

A patio, pergola, verandah, deck, balcony or the like (of any class having at least one side permanently open) or Class 5-10 building may be within the pool area.

Acceptable

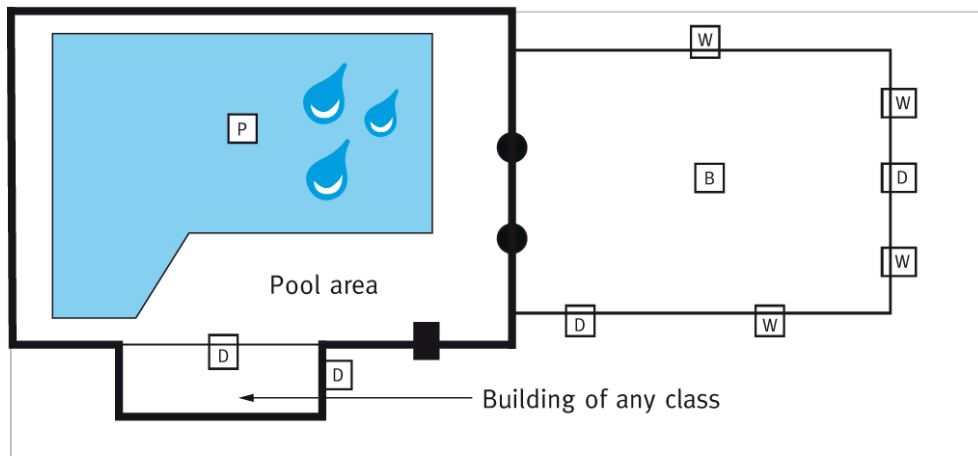

LEGEND:

- | | |
|-------------------------------|---|
| Pool | Child-resistant openable portion of window |
| Building | Property boundary |
| Door | Walls or line of the building |
| Window | Fence, retaining wall or other barrier complying with this part |
| Gate complying with this part | |

Figure 26

Access cannot be provided to the pool area through a building (of any class). A door must not be used, even if it is child resistant.

Not Acceptable

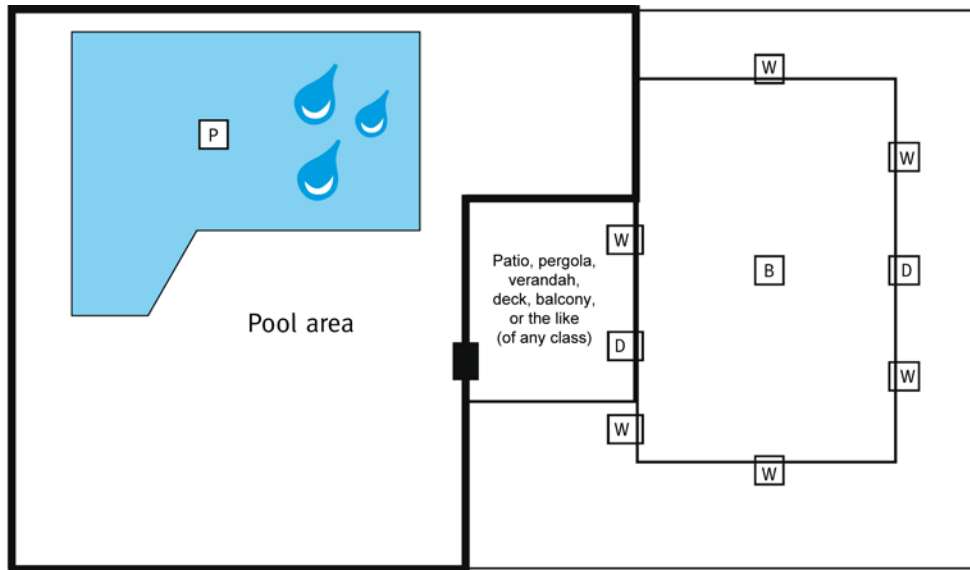

LEGEND:

P Pool

B Building

D Door

W Window

Gate complying with this part

Child-resistant openable portion of window

— Property boundary

— Walls or line of the building

Fence, retaining wall or other barrier complying with this part

A barrier may permit direct access to the pool area from a patio, pergola, verandah, deck, balcony or the like (of any class) having at least one side permanently open

Figure 27

Access from a Class 1, 2 or Class 4 part of a building to the pool area must be via a barrier complying with this part

Acceptable

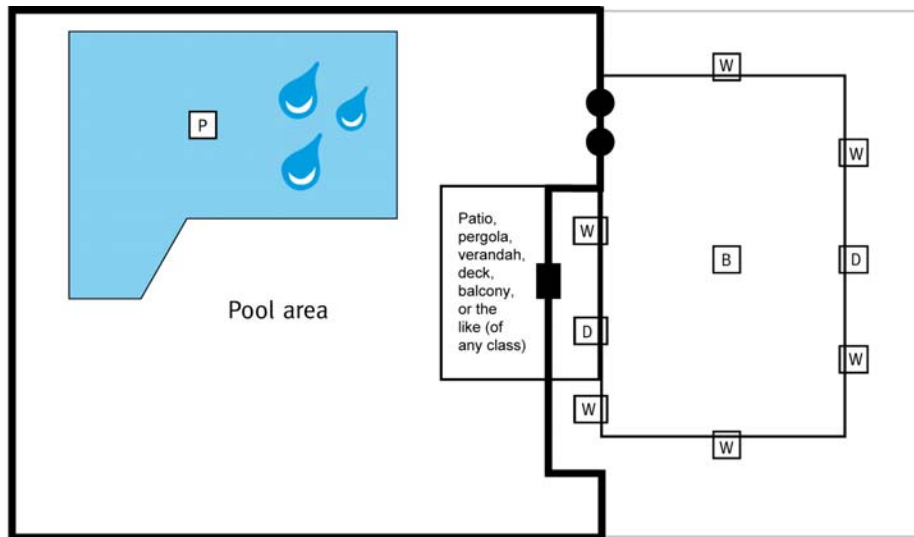

LEGEND:

P Pool

B Building

D Door

W Window

Gate complying with this part

Child-resistant openable portion of window

— Property boundary

— Walls or line of the building

— Fence, retaining wall or other barrier complying with this part

A barrier may permit direct access to the pool area from a patio, pergola, verandah, deck, balcony or the like (of any class) having at least one side permanently open







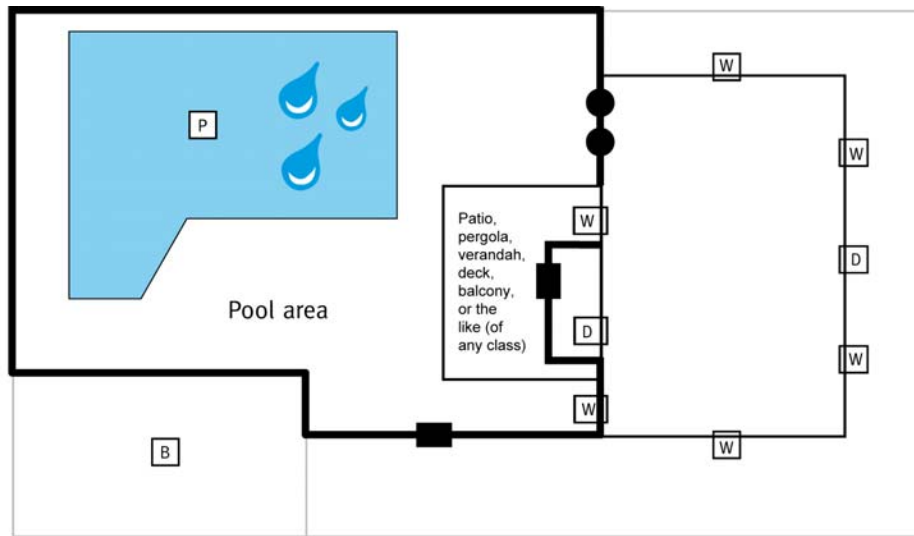

Figure 28

Access from a Class 1, 2 or Class 4 part of a building to the pool area must be via a barrier complying with this part which may be in a roofed outdoor area

Acceptable



LEGEND:

- | | |
|---|---|
|  Pool |  Child-resistant openable portion of window |
|  Building |  Property boundary |
|  Door |  Walls or line of the building |
|  Window |  Fence, retaining wall or other barrier complying with this part |
|  Gate complying with this part | |

A barrier may permit direct access to the pool area from a patio, pergola, verandah, deck, balcony or the like (of any class) having at least one side permanently open

Figure 29

Access from a Class 1, 2 or 3 building or Class 4 part of a building must be via a barrier complying with this part which may be in a roofed outdoor area
Acceptable

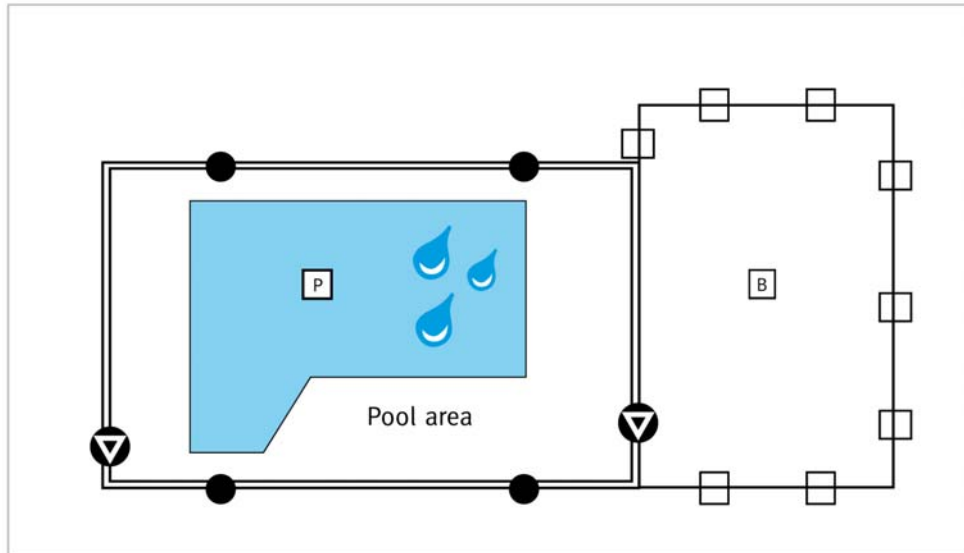

LEGEND:

P Pool

B Building

□ Window or door

▽ Door complying with this part

● Child-resistant openable portion of window

— Property boundary

— Walls or line of the building

▬ Pool area completely enclosed by the walls of a building

Indoor swimming pool completely enclosed by the walls of a building

Figure 30

For indoor swimming pools, access from Class 1, 2 or 3 buildings or Class 4 parts of buildings to the pool area must be via a barrier complying with this part

Acceptable

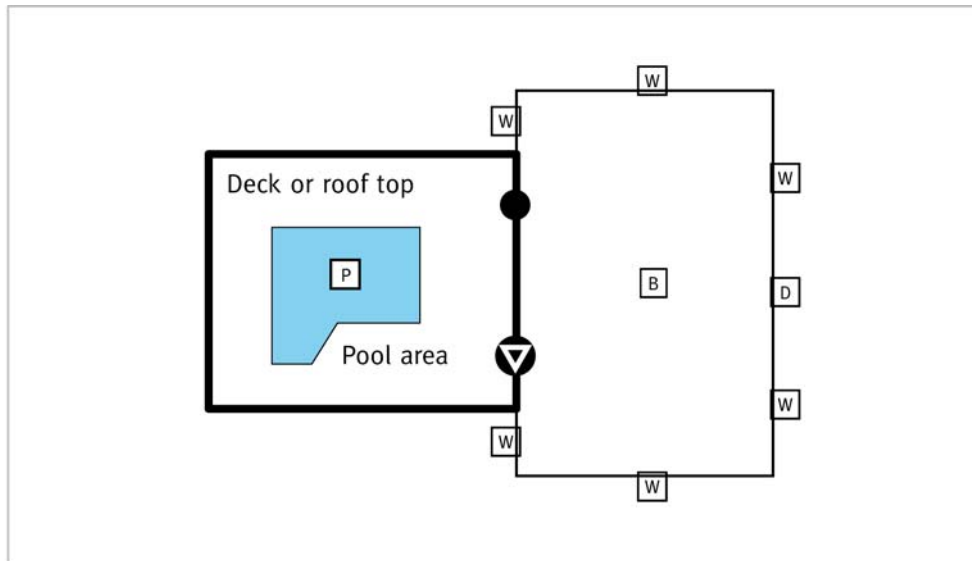

LEGEND:

- | | |
|-------------------------------|---|
| Pool | Child-resistant openable portion of window |
| Building | Property boundary |
| Door | Walls or line of the building |
| Window | Fence, retaining wall or other barrier complying with this part |
| Door complying with this part | |

Indoor swimming pool (including a spa) on a deck or roof top of a building

Figure 31

For indoor swimming pools, access from Class 1, 2 or 3 buildings or Class 4 parts of buildings to the pool area must be via a barrier complying with this part

Acceptable

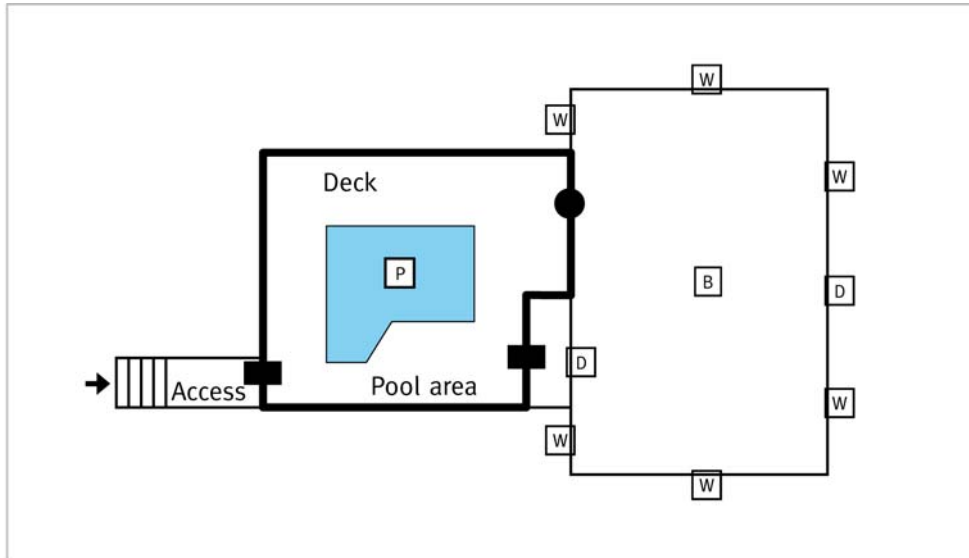

LEGEND:

- | | |
|--|---|
| P Pool | ● Child-resistant openable portion of window |
| B Building | — Property boundary |
| D Door | — Walls or line of the building |
| W Window | — Fence, retaining wall or other barrier complying with this part |
| ■ Gate complying with this part | |

Outdoor swimming pool (including a spa) on an accessible deck

Figure 32

Access from a Class 1, 2 or 3 building or Class 4 part of a building to the pool area must be via a barrier complying with this part

Acceptable